

INSTRUCTION MANUAL

OSCILLOSCOPE

MODEL COS5060

KIKUSUI ELECTRONICS CORPORATION

182.6.14

Power Requirements of this Product

Power requirements of this product have been changed and the relevant sections of the Operation Manual should be revised accordingly.

(Revision should be applied to items indicated by a check mark)

Input voltage

The input voltage of this product is _____ VAC,
and the voltage range is _____ to _____ VAC. Use the product within this range only.

Input fuse

The rating of this product's input fuse is _____ A, _____ VAC, and _____.

WARNING

- To avoid electrical shock, always disconnect the AC power cable or turn off the switch on the switchboard before attempting to check or replace the fuse.
- Use a fuse element having a shape, rating, and characteristics suitable for this product. The use of a fuse with a different rating or one that short circuits the fuse holder may result in fire, electric shock, or irreparable damage.

AC power cable

The product is provided with AC power cables described below. If the cable has no power plug, attach a power plug or crimp-style terminals to the cable in accordance with the wire colors specified in the drawing.

WARNING

- The attachment of a power plug or crimp-style terminals must be carried out by qualified personnel.

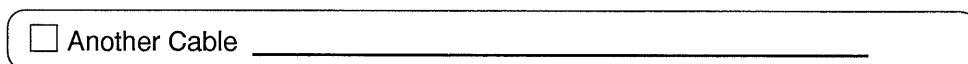
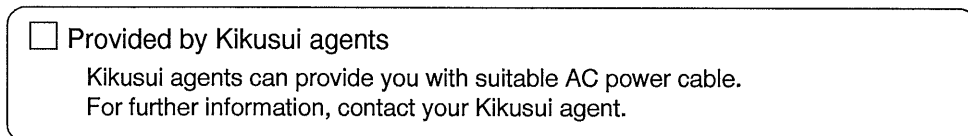
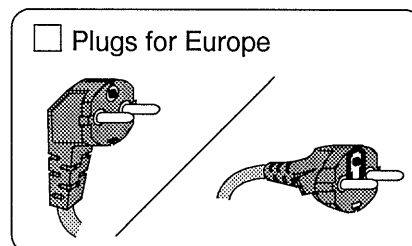
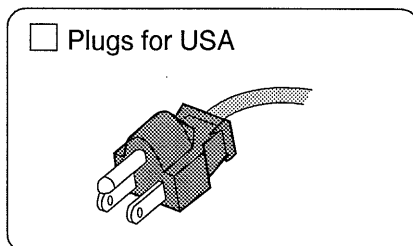
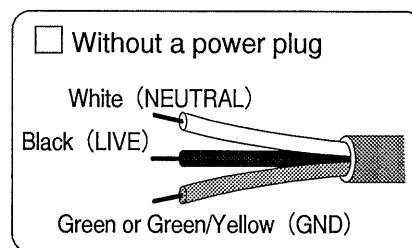
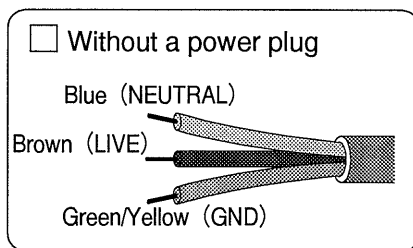

TABLE OF CONTENTS

	PAGE
1. GENERAL	1
1.1 Description	1
1.2 Features	1
2. SPECIFICATIONS	5
3. PRECAUTIONS BEFORE OPERATING THE OSCILLOSCOPE	13
3.1 Unpacking the Oscilloscope	13
3.2 Checking the AC Line Voltage	13
3.3 Environments	13
3.4 CRT Intensity	14
3.5 Maximum Voltages of Input Terminals	14
4. OPERATION METHOD	15
4.1 Explanation of Front Panel	15
4.2 Explanation of Rear Panel	22
4.3 Basic Operation	26
4.4 Vertical "MULTI MODE" Switches	28
4.5 CH3 HOR Operation	30
4.6 Triggering	31
4.7 Single-sweep Operation	40
4.8 Sweep Magnification	41
4.9 Waveform Magnification with Delayed Sweep	42
4.10 Delayed ALT Sweep	42
5. MEASURING	46
5.1 Connection Method of Input Signal	46
5.2 Voltage Measurement	49
5.3 Current Measurement	50
5.4 Time Measurement	51
5.5 Frequency Measurement	51
5.6 Measurement of Phase Difference	53
5.7 Characteristics of Pulse Waveform	54
5.8 Calibration of Probe	57

* BLOCK DIAGRAM

1. GENERAL

1.1 Description

Kikusui "5000 Series" Model COS5060 Oscilloscope responds to the customers needs in quality of performance, efficiency, function, design, and cost.

The COS5060 oscilloscope is rugged, highly reliable and a multi-purpose 3-channel 8-trace portable oscilloscope with a 6-inch Domed-mesh type 12 kV post deflection acceleration cathode-ray tube and with fine red internal graticule.

The vertical axis has a maximum sensitivity of 1 mV/DIV, a frequency response of up to 60 MHz -3dB, and a maximum sweep speed of 5 ns/DIV. A waveform magnification function with sweep delay is incorporated for real A, B dual time-base, therefore, this scope has many convenient features and special functions which make it an ideal instrument for diversified types of research and development of electronic equipment or circuitry. It can also be efficiently used in production line maintenance and service applications. The features of the COS5060 Oscilloscope can be summarized as follows.

1.2 Features

(1) Compactness, light-weight, ruggedness and simple-design:

The diecast frame provides compactness light-weight and ruggedness. The superior structural design is the ultimate in simplicity.

(2) Ease of operation:

Light torque lever switches and pushbutton switches are used. These and other controls are laid out in the most convenient locations making the oscilloscope extremely easy to operate.

- (3) High-brightness CRT, high acceleration voltage. (12 kV):

The high acceleration voltage and high beam-efficiency of the 80 mm × 100 mm rectangular CRT ensures a bright trace for high speed sweep observation.

- (4) Multi-mode display system:

CH1. CH2. ADD. CH3 (trigger view) any combination or all the channels may be viewed simultaneously with a simple adjustment of the MULTI-MODE display buttons. Maximum 8 trace displaying is possible with the ALT sweep function.

- (5) Dynamic bias circuitry (PAT. PEND):

The energy-saving design makes use of automatic electric power consumption control circuitry so that, when the indicated signal waveforms are small or the frequency components are low operations are performed with minimum use of electricity.

- (6) High stability and low-drift:

The new circuits are desinged and adopted with a temperature drift-compensation circuitry for minimizing any kind of drift and stable DC balance.

- (7) High sensitivity and wide frequency bandwidth:

The maximum vertical sensitivity is 1 mV/DIV (with 5 ×MAG) 20 MHz or greater -3 dB and 5 mV/DIV at 60 MHz or greater -3 dB.

- (8) High input impedance:

The input impedance of CH1, CH2, CH3 (trigger view) is 1 MΩ ±1%, 25 pF ±2 pF, allowing the use of 10× probes.

- (9) "VERT MODE" TRIGGER FUNCTION:

When in the VERT MODE trigger mode, stable triggering can be attained even when the signals of CH1, CH2 are not time related.

(10) Maximum sweep speed 5 ns/DIV:

With $\times 10$ MAG function the highest sweep speed of 50 ns/DIV can be multiplied by a factor of 10 to attain a maximum sweep speed of 5 ns/DIV.

(11) Alternate sweep:

The A sweep and the delayed sweep can be viewed simultaneously in the alternate mode.

(12) 2 channel X-Y operation:

CH3 may be used as EXT HORIZ input allowing CH1 and CH2 to be used as vertical inputs for DUAL channel X-Y displays.

(13) Trigger level lock:

A new trigger level lock circuit which controls the trigger signal and performs automatic adjustments of the trigger level, even for VIDEO signals and signals of large duty cycles. This is an operation step-saver which eliminates the need for manual trigger level adjustment.

(14) TV sync. triggering:

The COS5060 has a sync separator circuit, which allows triggering for TV.V signal and TV.H signal. It is automatically switched with the TIME/DIV control.

(15) Variable holdoff function:

Digital and other signals with complex repeating periods which resist triggering can be stably triggered with a simple adjustment of the hold off level.

(16) Linear focus:

Once the beam focus is adjusted, it is automatically maintained in this state regardless of changes in intensity.

(17) CH1 signal output:

The CH1 signal output allows connection to frequency counters and other devices at all levels.

2. SPECIFICATIONS

Vertical axes

Item	Specification	Remarks
CH1 and CH2 Sensitivity	5 mV/DIV - 5 V/DIV 1 mV/DIV - 1 V/DIV (when $\times 5$ MAG)	1-2-5 sequence, 10 positions
Sensitivity accuracy	$\pm 3\%$ $\pm 5\%$ (when $\times 5$ MAG)	10 to 35°C (50 to 95°F), 1 kHz, at 4 or 5 DIV
Variable vertical sensitivity	To 1/2.5 or less of panel-indicated value	
Frequency bandwidth	DC - 60 MHz (-3 dB) DC - 20 MHz (-3 dB), when $\times 5$ MAG AC coupling: Low limit frequency 10 Hz	With reference to 50 kHz, 8 DIV.
Input coupling	AC, DC, GND	
Input impedance	1 M Ω $\pm 1\%$, 25 pF ± 2 pF	
Allowable input voltage	400 V (DC + AC peak)	Frequency 1 kHz or lower
Square wave characteristics	Overshoot: Not greater than 5% (at 10 mV/DIV range) Other distortions: Not greater than 3% (at 10 mV/DIV range)	Other ranges: Add 3% VARIABLE knob is CAL'D position. 10 to 35°C (50 to 95°F)
CH3 Sensitivity	EXT input terminal used in common. 0.1 V, 1 V/DIV	
Sensitivity accuracy	$\pm 3\%$	10 to 35°C (50 to 95°F), at 8 DIV
Frequency bandwidth	DC - 60 MHz (-3 dB) AC coupling: Low limit frequency 10 Hz	With reference to 50 kHz, 8 DIV.

Item	Specification	Remark
Input coupling	AC, HF REJ, TV, DC	
Allowable input voltage	100 V (DC + AC peak)	Frequency 1 kHz or lower
Square wave characteristics	Overshoot: Not greater than 10% Other distortions: Not greater than 5%	10 to 35°C (50 to 95°F)
Rise time	Approx. 6 nsec (Approx. 17.5 nsec when ×5 MAG)	
Signal delay time	Approx. 40 nsec (with delay cable of approx. 120 nsec)	The displayed portion preceding the triggering point
Delay time differences among channels	Not greater than ±0.5 nsec among CH1, CH2 and among another channel ±2.0 nsec	
Polarity change	CH2 only	
DC balance shift	±0.5 DIV (±2.0 DIV when in ×5 MAG)	
Display modes	Simultaneous displays of CH1, ADD (CH1 + CH2), CH2, CH3 are possible in any combination. ALT, CHOP: Switchable X-Y: TIME/DIV switch change to <input type="checkbox"/> X-Y <input type="checkbox"/> CH3 HOR and SOURCE switch to <input type="checkbox"/> X-Y.	Simultaneous X-Y displays of CH1, CH2, ADD and CH3, at CHOP MODE
Chopping repetition frequency	1 MHz/ number of displayed channels ±40%	
Common mode rejection ratio	50:1 or better at 50 kHz, sinusoidal wave	When sensitivities of CH1 and CH2 are set equal
CH1 signal output	Approx. 50 mV/DIV at 50Ω termination	Approx. 100 mV/DIV at open
CH2 INV BAL	Balanced point. Not greater than 1 DIV	Reference at center graticule

Item	Specification	Remark
Isolation between channels	At least 1000:1 at 50 kHz At least 30:1 at 60 MHz	At 5 mV/DIV range
Linearity	Within ± 0.1 DIV when signal with 2 DIV amplitude in screen center is moved to upper or lower.	

Triggering

Item	Specification	Remark
Internal trigger selection (INT TRIG)	CH1, CH2 and "VERT MODE" (Trigger source is selected depending on the vertical operation mode.) When in ADD, the CH1 input signal is used at the trigger source signal.	VERT MODE function works in ALT sweep MODE between CHs and single CH alone operation
A trigger		
Signal source	INT, LINE, EXT, EXT/10	
Coupling	AC, HF REJ, TV, DC	
Polarity	+ or -	
Sensitivity	DC - 10 MHz: 0.4 DIV (0.04 V) 10 - 60 MHz: 1.5 DIV (0.15 V) Video signal: 2.0 DIV (0.2 V) <div style="display: flex; align-items: center; justify-content: center;"> <div style="font-size: 4em; margin-right: 10px;">(</div> <div style="text-align: center;"> <p>AC coupling: Attenuates signal components of lower than 10 Hz.</p> <p>HF REJ: Attenuates signal components of higher than 50 kHz.</p> </div> <div style="font-size: 4em; margin-left: 10px;">)</div> </div>	The values enclosed in the parentheses are the input sensitivities when in the EXT trigger mode.
B trigger		
Signal source	B trigger source is A trigger source.	

Item	Specification	Remarks
EXT trigger input	CH3 input terminal used in common	
Input impedance	1 M Ω \pm 2%, 25 pF \pm 2 pF	
Maximum allowable input voltage	100 V (DC + AC peak)	Frequency 1 kHz or lower
AUTO mode	Satisfies the trigger sensitivity specification for signal repetition frequency of 50 Hz or over.	
LEVEL LOCK	Satisfies the value of the above trigger sensitivity plus 0.5 DIV (0.05 V) for signal of duty cycle 20:80 and repetition frequency 50 Hz - 50 MHz.	

Horizontal axis

Item	Specification	Remarks
Horizontal axis display	A, ALT (A INT), B (DLY'D)	
A sweep		
Sweep mode	AUTO, NORM, SINGLE	
Sweep time	0.05 μ sec/DIV - 0.5 sec/DIV 5 nsec/DIV - 50 msec/DIV (when in "x10 MAG")	1-2-5 sequence, 22 positions
Sweep time accuracy	\pm 3%	10 to 30°C (50 to 95°F)
Variable sweep time	To 1/2.5 or slower of panel-indicated value	
Holdoff time	Continuously variable to 2 times or over of sweep length (time) at 0.05 μ sec/DIV - 10 msec/DIV ranges	

Item	Specification	Remarks
B sweep		
Delay system	Continuous delay or triggered delay	
Sweep time	0.05 μ sec/DIV - 50 msec/DIV 5 nsec/DIV - 5 msec/DIV (when in "x10 MAG")	1-2-5 sequence, 19 positions
Sweep time accuracy	$\pm 3\%$	10 to 35°C (50 to 95°F)
Delay time	0.5 μ sec - 5 sec	
Delay time accuracy	$\pm 3\%$ of multial-indicated value (except 0 - 0.50) $\pm 4\%$ of value read on graticule	
Delay jitter	1/10,000 or less $\frac{\text{B sweep time}}{\text{A sweep time}} \times \frac{\text{jitter width}}{10 \text{ DIV}}$	Jitter width 1.0 DIV or less at A: 1 msec/DIV B: 1 μ sec/DIV
Sweep magnification	10 times (maximum sweep time 5 nsec/DIV)	Both A and B
Magnified sweep time accuracy	0.1 μ sec/DIV - 0.5 sec/DIV ranges: $\pm 5\%$ 0.05 μ sec/DIV range: $\pm 8\%$	10 to 35°C (50 to 95°F)
Linearity	$\pm 3\%$ $\pm 5\%$ (when in "x10 MAG)	
CH3 sweep (CH3 HOR)	CH3 (EXT TRIG) input signal is used as sweep trigger signal. (For vertical axes, any combination of CH1, ADD (CH1 + CH2), CH2, and CH3 can be simultaneously displayed in CHOP mode.)	
Sensitivity	0.1 V, 1 V/DIV	Same as CH3
Sensitivity accuracy	$\pm 3\%$	Same as CH3

Item	Specification	Remarks
Frequency bandwidth	DC - 2 MHz (-3 dB)	With reference to 50 kHz, 10 DIV
Phase difference between vertical axes	Not greater than 3° at DC - 100 kHz	
X-Y mode	X-axis: CH1 input signal Y-axis: CH2 input signal	
Sensitivity	5 mV - 5 V/DIV	Same as CH1
Sensitivity accuracy	±4% NORM ±5% (when in "×10 MAG")	10 to 35°C (50 to 95°F), 1 kHz, at 4 or 5 DIV
Frequency bandwidth	DC - 2 MHz (-3 dB) AC coupling: Low limit frequency 10 Hz	With reference to 50 kHz, 10 DIV
X-Y phase difference	Not greater than 3° at DC - 100 kHz	

Z axis

Item	Specification	Remarks
Sensitivity	3 Vp-p (Trace becomes brighter with negative input.)	
Frequency bandwidth	DC - 5 MHz	
Input resistance	5 kΩ ±10%	
Allowable input voltage	50 Vp-p (DC + AC peak)	AC: 1 kHz or lower

Calibration voltage

Item	Specification	Remarks
Waveform	Positive-going square wave	
Frequency	1 kHz \pm 5%	
Duty ratio	Within 45:55	
Output voltage	2 V _{p-p} , \pm 2%	
Output resistance	Approx. 2 k Ω	

CRT

Item	Specification	Remarks
Type	6-inch rectangular CRT, internal graticule	
Fluorescent screen	P31 phosphor	
Acceleration voltage	Approx. 12 kV	
Effective screen size	8 \times 10 DIV	1 DIV = 10 mm (0.39 in.)
Graticule	Internal graticule, continuously adjustable illumination	

Mechanical specifications

Item	Specification	Remarks
Dimensions of mainframe	280 W \times 150 H \times 370 D mm (11.02 W \times 5.91 H \times 14.56 D in.)	
Maximum dimensions	340 W \times 200 H \times 455 D mm (13.39 W \times 7.87 H \times 17.91 D in.)	
Weight	Approx. 7.0 kg (15.4 lbs)	

81 '7' '78,

o Line power requirements

Voltage: 100 V, 115 V, 215 V, 230 V; with 10% allowance.
 Selectable by connector change

Frequency: 50 Hz or 60 Hz

Wattage: Approx. 40 VA

o Operating environment

To satisfy specifications: 5 to 35°C (41 to 95°F),
 85% RH

Maximum operating ranges: 0 to 40°C (32 to 104°F),
 90% RH

o Accessories

P060-S probes (10:1, 1:1, 1.5 m)	(89-03-0300)	...	2
942A terminal adaptors	(W4-986-011)	...	3
Fuse (1 A or 0.5 A)	(99-02-0100)	...	1
	(99-02-0101)		
Power cord	(85-10-0120)	...	1
Instruction manual	()	...	1

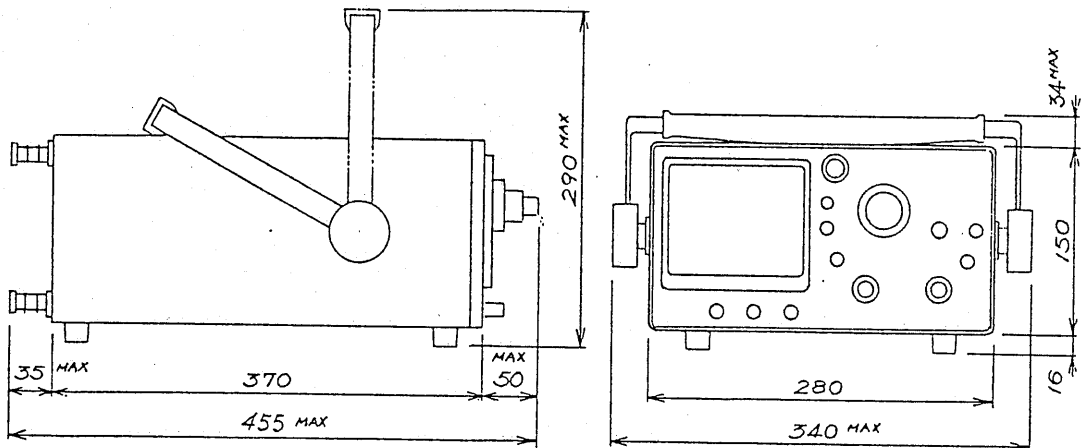

o Specifications and contents on this manual are subject to change without notice.

3. PRECAUTIONS BEFORE OPERATING THE OSCILLOSCOPE

3.1 Unpacking the Oscilloscope:

Upon receipt of the instrument, please unpack and inspect it for any damage which might have been sustained during transportation. If any sign of damage is found, please notify the bearer or the dealer.

3.2 Checking the AC Line Voltage:

This instrument can be operated on any one of the AC line voltages shown in the following table. The required voltage can be selected by means of the voltage selector plug. Before operating the instrument, ensure that the AC line voltage setting of the instrument conforms with the voltage of the AC line on which the instrument is to be operated. If the instrument voltage does not conform with the line voltage, the instrument may not operate normally or may be permanently damaged.

When the instrument AC line voltage is changed, change the fuse by referring to the following table.

Symbol	Center voltage	Operating voltage range	Fuse
A	100 V	90 - 110 V	1 A
B	115 V	104 - 126 V	
C	215 V	194 - 236 V	0.5 A
D	230 V	207 - 253 V	

3.3 Environment:

The normal ambient temperature range of this instrument is 5°C - 35°C (41°F - 95°F). Operation of the instrument outside of this temperature range may cause damage to the circuits.

3.4 CRT Intensity:

In order to prevent permanent damage to the CRT, do not make the CRT trace excessively bright or leave the spot stationary for more than a few moments.

3.5 Maximum Voltages of Input Terminals:

The withstanding voltages of the instruments input terminals and probe input terminals are shown in the following table. Do not apply voltages higher than these limits.

CH1, CH2 inputs	400 Vp-p (DC + AC peak)
Probe input	600 Vp-p (DC + AC peak)
CH3 input	100 Vp-p (DC + AC peak)
Z AXIS input	50 Vp-p (DC + AC peak)

Note: AC frequency is 1 kHz or below.

4. OPERATING

4.1 Explanation of Front Panel (See Figure 4-1.)

o CRT circuits:

- POWER ① Main power switch of the instrument.
When this switch is turned on, lamp
③⑨ is also turned on.
- INTEN ② Controls the brightness of the spot
or trace.
- B INTEN ③ Semi-fixed potentiometer for adjusting
the intensified sweep or B sweep
brightness.
- FOCUS ④ For focussing the trace to the sharpest
image.
- ILLUM ⑥ Graticule illumination adjustment.
- TRACE ROTATION ⑤ Semi-fixed potentiometer for aligning
the horizontal trace in parallel with
graticule lines.

o Calibration Voltage:

- CALIB 2 Vp-p ④⑩ Terminal for 2 Vp-p calibration voltage
output. Output resistance is approxi-
mately 2 kΩ.

o Vertical Axis:

- CH1 (X) input ⑧ Vertical input terminal of CH1.
When in X-Y operation, X axis (abscissa)
input terminal.
- CH2 (Y) input ⑮ Vertical input terminal of CH2.
When in X-Y operation, Y axis (ordinate)
input terminal.
- GND ⑫ Ground terminal of instrument

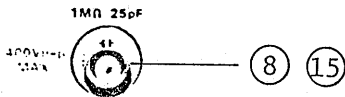

AC-GND-DC (7) (16)

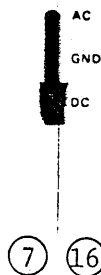

Switch for selecting connection mode between input signal and vertical amplifier.

AC: AC coupling

GND: Vertical amplifier input is grounded and input terminals are disconnected.

DC: DC coupling

VOLTS/DIV (10) (13)

Selects the vertical axis sensitivity, from 5 mV/DIV to 5 V/DIV with 10 ranges.

VARIABLE (11) (14)

Fine adjustment of sensitivity, with a factor of 1/2.5 or over the panel-indicated value. When in the CAL'D position, sensitivity is calibrated to the panel-indicated value.

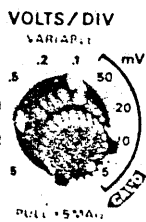

×5 MAG (11) (14)

When this knob is pulled out, the sensitivity of the vertical amplifier is multiplied by 5 times.

↑ POSITION (9) (17)

Vertical position control of the trace or spot.

CH2 PULL INV (17)

When this knob is pulled out, the switch selects the polarity of the signal applied to CH2 input terminal.



VERT MODE (19)

Selects the operation mode of the vertical axis.

(MULTI MODE)

CH1: CH1 operates alone.

CH2: CH2 operates alone.

ALT: Dual-channel operation with CH1 and CH2 swept alternately. Suitable for observation with fast sweep speeds.



CHOP: The operation between channels chopped at a frequency of approximately 1 MHz/number of displayed channels. Suitable for observation with slow sweep speeds.

ADD: For measurement of algebraic sum or difference of CH1 and CH2 signals, employing the function of CH2 PULL INV switch.

CH3: By depressing the CH3 button and SOURCE switch (23) is positioned to INT. It is possible to look at TRIG VIEW.

SOURCE switch (23) is positioned to EXT (CH3) or EXT + 10). It is possible to observe the EXT input signal of CH3 input terminal.

INT TRIG (18)

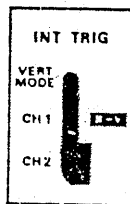

(18) Selects the internal trigger signal source. The signal selected by this switch is fed to the A trigger circuit if SOURCE switch (23) is set in the INT state.

CH1: The input signal of CH1 is used as (X-Y) the trigger signal and the signal is connected to the X axis during X-Y operation.

(18) **VERT MODE:** The input signal which is displayed on the CRT screen is used as the trigger signal. When in this mode, triggering also is in an alternate mode and the signals of both CH1 and CH2 are alternately used for triggering respective channels.

NOTICE: It is necessary to use TRIG LEVEL knob (21) to adjust the level for obtaining the best triggering.

o Trigger Circuit:

- CH3 INPUT (EXT) (20) Input terminal for an external trigger signal, and also for CH3 input terminal.
 0.1 V/DIV
- SOURCE (23) Selects the trigger signal.

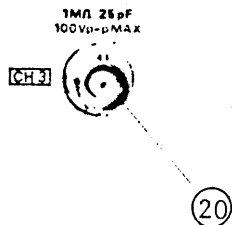

INT: Internal signal selected by INT (X-Y) TRIG switch (18) is used as the trigger signal and also connected signal when X-Y operation.

LINE: AC line signal is used as the trigger signal.

EXT: The input signal of EXT TRIG (CH3) INPUT terminal (20) is used as the trigger signal.

EXT ÷ 10: The input signal of EXT TRIG INPUT terminal is attenuated by a factor of 1/10 and used as the trigger signal.

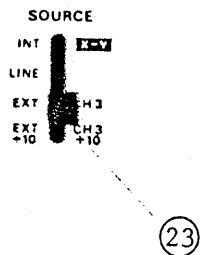

- COUPLING (24) Selects coupling mode between trigger source circuit and trigger circuit and also selects connection mode for the TV sync. circuit.

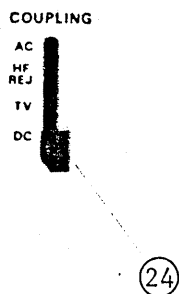

AC: Trigger signal is applied through an AC coupling circuit.

HF REJ: Trigger signal is applied through an AC coupling circuit, with attenuation of signal components higher than 50 kHz.

TV: TV sync. separation circuit is connected to the trigger circuit, and the sweep is triggered in synchronization with TV.V or TV.H signal at sweep speed selected by the A TIME/DIV switch (31).

TV.V: 0.5 sec - 0.1 msec/DIV

TV.H: 50 μsec - 0.05 μsec/DIV

LEVEL

21 Controls the trigger level for setting the starting point of the displayed waveform. As this knob is turned in "→ +" direction, the trigger level moves upward on the displayed waveform; as the knob is turned "← -", the level moves downward.

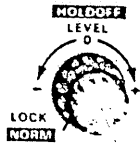

22

21

When set in the LOCK position, the trigger level is automatically maintained at an optimal value irrespective of the signal amplitude (from very small amplitude to large amplitude), requiring no manual adjustment of trigger level.

HOLD OFF

22 Complex repeating periods which resist triggering can be stably triggered with a simple adjustment of the hold off.

SLOPE

27 Selects the triggering slope.



27

"+": Triggering occurs when the trigger signal crosses the trigger level in a positive-going direction.

"-": Triggering occurs when the trigger signal crosses the trigger level in a negative-going direction.

TRIG'D

28 When the A sweep operates, the TRIG'D lamp 28 will turn on.

o Sweep Circuits

A, B TIME/DIV
AND DELAY TIME

31 The large knob 31 is for A TIME/DIV and DELAY TIME, and the medium knob 32 is for B TIME/DIV.

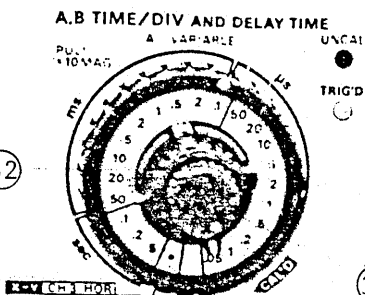

29

28

The A TIME/DIV knob sets the A sweep rate; the DELAY TIME knob sets the delaying sweep rate.

The B TIME/DIV switch sets the delayed sweep rate.

33

31

A VARIABLE (33) Continuously-variable adjustment of the A sweep rate. The value indicated by A TIME/DIV switch (31) can be reduced by a factor of 2.5 or more. When set in the CAL'D position, the sweep speed is calibrated to the value indicated by the A TIME/DIV switch. When not in the CAL'D position, the UNCAL lamp (29) turns on.

×10 MAG (33) When this knob is pulled out, the A or B sweep is expanded by 10 times and, therefore, the sweep time becomes 1/10.
(VARIABLE)

POSITION (36) Horizontal position control of spot or trace.
↔

DELAY TIME MULTI (34) Multi-turn potentiometer for continuously variable adjustment of the delay time indicated by the A sweep knob (31) in order to select the section of the A sweep to be expanded.

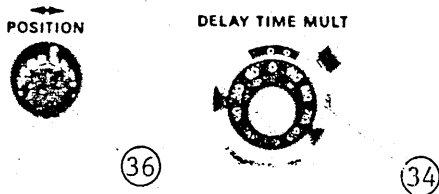

SWEEP MODE (26) Selects the desired sweep mode.

(26)



AUTO: When no adequate triggering signal is applied or when signal frequency is less than 50 Hz, sweep runs automatically.

NORM: When no adequate triggering signal is applied, sweep is in a ready state and the return trace is blanked out. Used primarily for observation of signals of 50 Hz or lower.

SINGLE: Used for single sweep operation (PUSH TO) (one-shot sweep operation) in (RESET) conjunction with the reset switch.

When the three buttons are in the pushed out state, the circuit is in the single sweep mode. The circuit is reset as this button is pressed. When the circuit is reset, the READY lamp (25) turns on. The lamp goes off when the single sweep operation is over.

HORIZ DISPLAY (30) Selects A and B sweep mode as follows:

A: Main sweep (A sweep) mode for general waveform observation.

ALT: A sweep, A INT by B, and B sweep (delayed sweep) are displayed alternately. (The A, B TRACE SEPARATION control (35) is used to set vertical separation so that the waveforms can be clearly observed.

B: Displays the delayed sweep (B sweep) alone.

B TRIG'D: Selects between continuous delay and triggered delay.

\square : For continuous delay. The sweep starts immediately after the sweep delay time determined by DELAY TIME switch (31) and DELAY TIME MULTI knob (34), irrespective of B trigger signal.

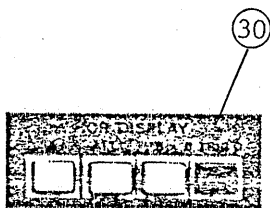

☐ : For triggered delay. Sweep starts with B trigger signal after the sweep delay time determined by DELAY TIME switch (31) and DELAY TIME MULTI knob (34). (Controls for the B trigger circuit are located on the rear panel. B trigger signal is used commonly A trigger signal.)

A, B TRACE (35)

SEPARATION



(35) Semi-fixed potentiometer for separating the vertical positions of the A and B sweeps when in the ALT mode.

CAL (Vp-p) (40)



(40) Calibration terminal. Approx 1 kHz, positive going square wave.

2 V: 2 Vp-p signal output resistance is approx. 2 kΩ.

OTHERS (37)

(37) Bezel, for installing a camera mount option (OU-1)

(38)

Contrast-filter, blue filter for ease of waveform observation can be easily removed.

4.2 Explanation of Rear Panel (See Figure 4-2.)

o CH1 SIGNAL OUTPUT ... (51)

This output terminal provides CH1 signal which can be fed to a frequency counter, etc.

o Z Axis

Z AXIS INPUT (52)

Input terminal for a external intensity modulation signal. Binding post terminal with 19-mm (0.75 in.) spacing.

o CH3 POSITION (53)

POSITION CONTROL for CH3, INT or EXT TRIG VIEWING.

o AC Power Input Circuit

FUSE (54) Fuse in the primary circuit of the power transformer. Fuse rating is as shown in the AC line voltage table (56) on the instrument rear panel.

AC power input connector (55) Input connector of the AC power of the instrument. Connect the AC power cord (supplied) to this connector.

AC voltage selector plug (57) For selecting the AC voltage of the instrument in conjunction with selector connector, as indicated with A, B, C, D symbols referenced to the AC line voltage table (56) on the instrument rear panel.

(58) This is the production number to identify which instruments were produced in the KIKUSUI factory. Please notify this number if you need our SERVICE.

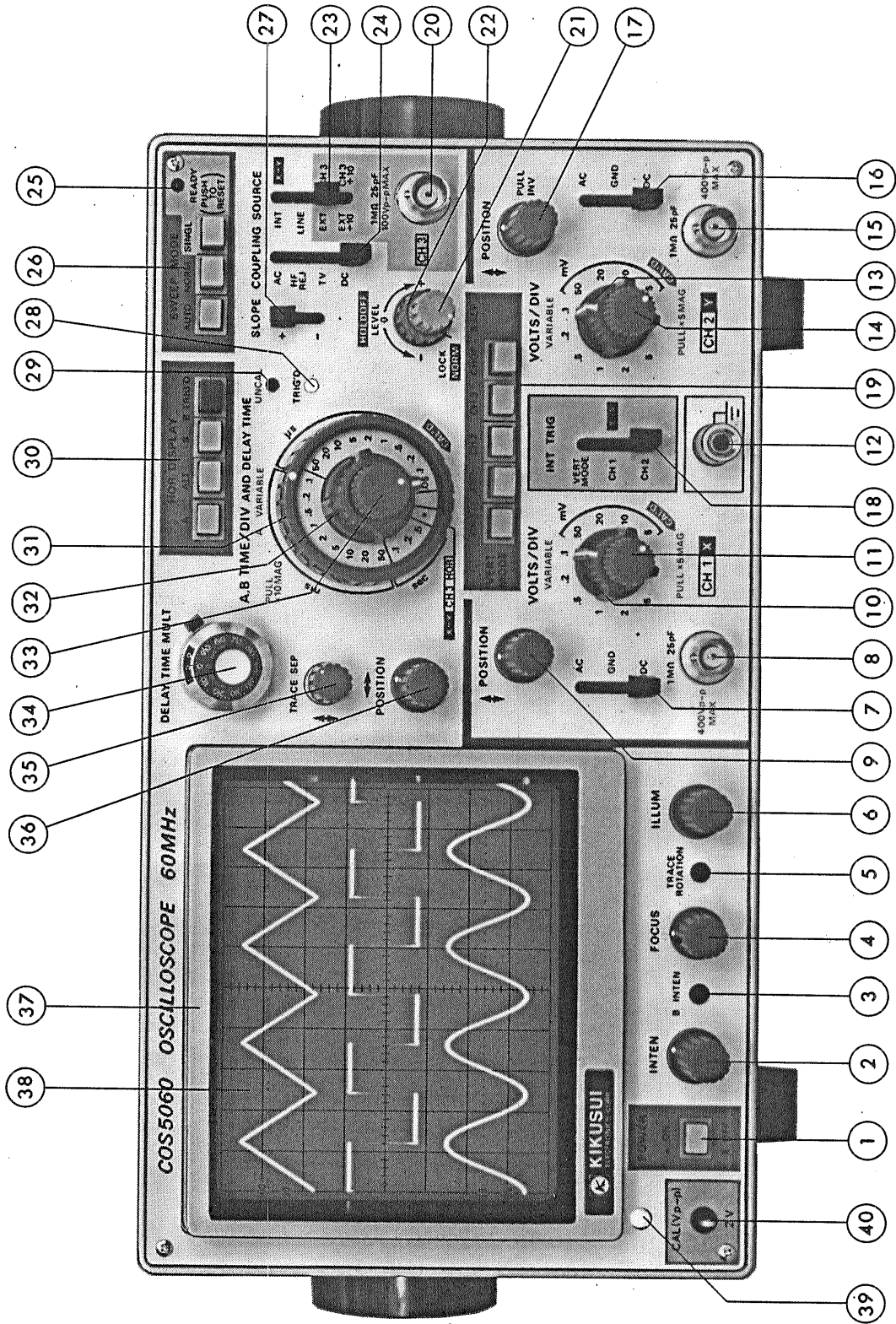

Figure 4-1

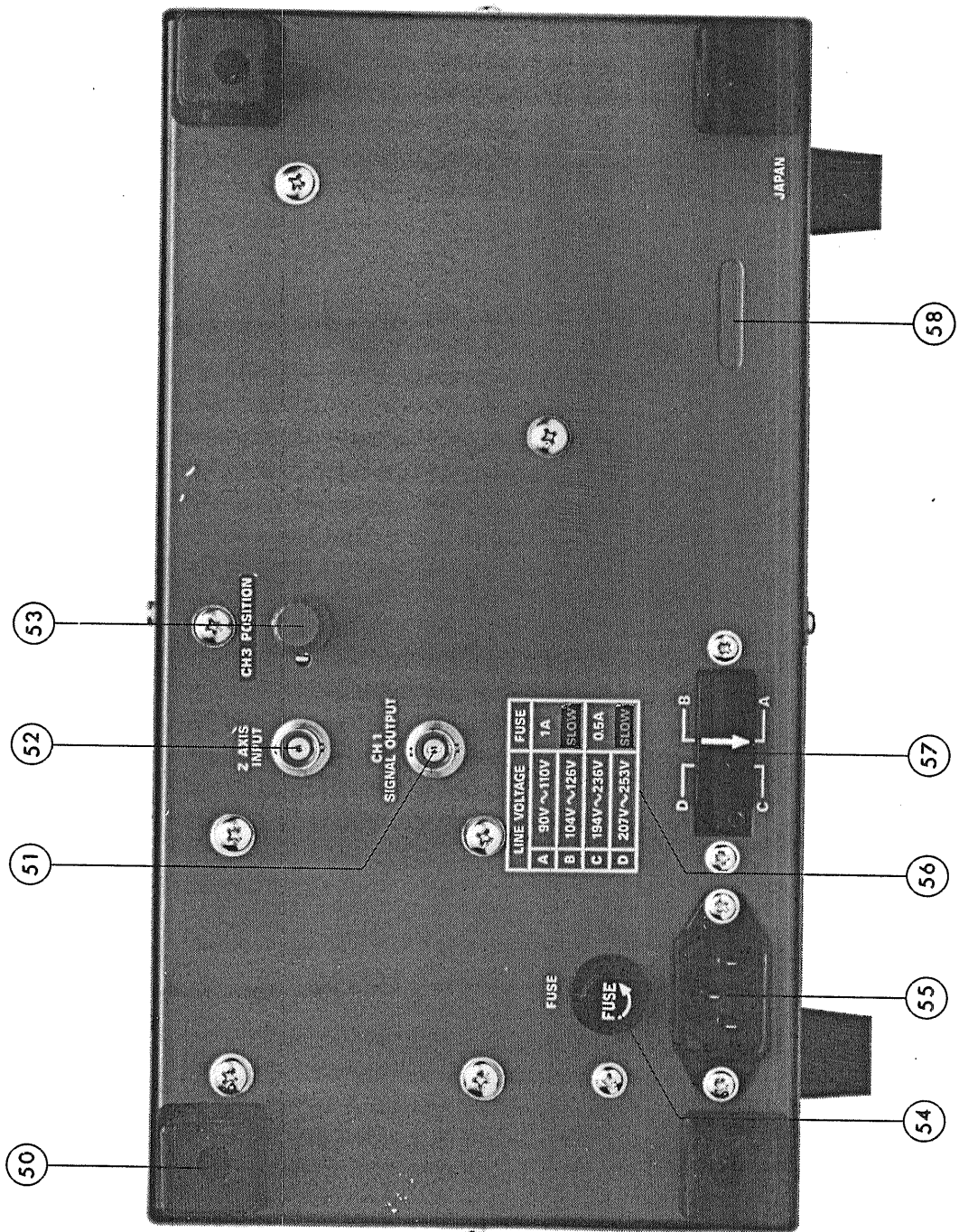

Figure 4-2

4.3 Basic Operation

Before connecting the power cord to an AC line outlet, check that the AC line voltage selector plug on the rear panel of the instrument is correctly set for the AC line voltage. After ensuring the voltage setting, set the switches and controls of the instrument as shown in the following table.

Item	No.	Setting
POWER	①	<input type="checkbox"/> OFF position
INTEN	②	Clockwise (3-o'clock position)
FOCUS	④	Mid-position
ILLUM	⑥	Counterclockwise position
VERT MODE	⑱	All buttons in <input type="checkbox"/> state
↑ POSITION	⑨ ⑰	Mid-position
CH3 POSITION	⑤③	Mid-position (on rear panel)
VOLTS/DIV	⑩ ⑬	50 mV
VARIABLE (×5 MAG)	⑪ ⑭	CAL'D (clockwise position) Depressed state
AC-GND-DC	⑦ ⑰	GND
INT TRIG	⑱	VERT MODE
SOURCE	⑳	INT
COUPLING	㉔	AC
SLOPE	㉗	+
LEVEL	㉑	LOCK (counterclockwise)
HOLDOFF	㉒	NORM (counterclockwise)
↑ TRACE SEP	㉕	Mid-position
SWEEP MODE	㉖	AUTO
HOR DISPLAY	㉓	A
A, B TIME/DIV	㉙ ㉚	0.5 msec

Item	No.	Setting
VARIABLE ×10 MAG	33	CAL'D (clockwise position) Depressed state
↔ POSITION	36	Mid-position

After setting the switches and controls as above, connect the power cord to the AC line outlet and, then, proceed as follows:

- 1) Turn-ON the POWER switch and make sure that the power pilot LED above is turned on. In about 20 seconds, a trace will appear on the CRT screen. If no trace appears in 60 seconds, verify the switch and control settings in the above table.
- 2) Adjust the trace to an appropriate brightness and sharpest image with the INTEN control and FOCUS control.
- 3) Align the trace with the horizontal center line of the graticule by adjusting the CH1 POSITION control and TRACE ROTATION control (screwdriver adjust).
- 4) Connect the P060-S 10:1 probe (supplied) to the CH1 INPUT terminal, and apply the 2 Vp-p CALIBRATOR signal to the probe tip.
- 5) Set the AC-GND-DC switch in the AC state. A waveform as shown in Figure 4-3 will be displayed on the CRT screen.

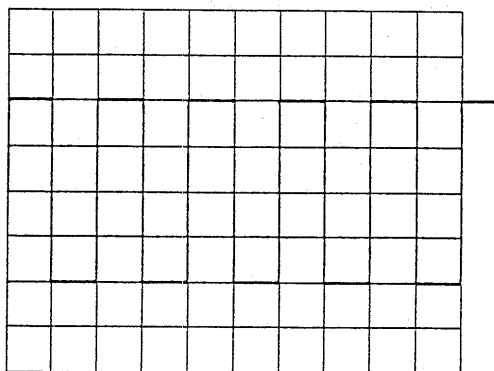

Figure 4-3

817778

- 6) Adjust the FOCUS control so that the trace image becomes sharpest. No re-adjustment will be necessary since the linear focus circuitry will automatically maintain the image in the best focussed state.
- 7) For signal observation, set the VOLTS/DIV switch and TIME/DIV switch in appropriate positions so that the signal waveform is displayed with an appropriate amplitude and an appropriate number of peaks.
- 8) Adjust the \updownarrow POSITION and \leftrightarrow POSITION controls in appropriate positions so that the displayed waveform is aligned with the graticule and the voltage (V_{p-p}) and period (T) can be read conveniently.

The above is the basic operating procedure of the oscilloscope. Further operation methods are explained in the subsequent paragraphs.

4.4 Vertical "MULTI MODE" Switches

The vertical mode switches of the oscilloscope are comprised of five mode selector switches as shown in the following:

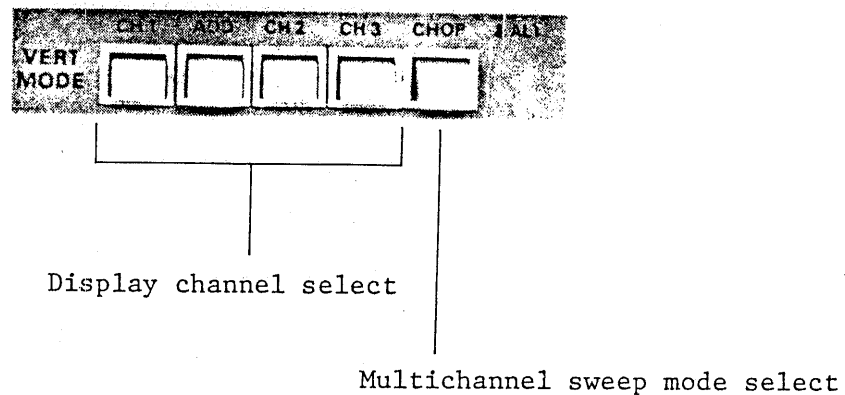

Figure 4-4

These mode switches can be set in any combination.

(1) Single-channel operation

For the signal-channel operation, depress one of the display channel buttons (\square) and leave the remaining display channel buttons extended (\square). If none of the display channel buttons are depressed (\square), CH1 signal is displayed.

Note: Either CH1, ADD (CH1 + CH2), CH2, CH3 (TRIG VIEW) can be viewed independently of each other.

(2) Multichannel operation

For multichannel operation, depress only the required display channel buttons and leave all other vertical mode buttons extended. Set the CHOP/ALT button in the CHOP or ALT mode as required.

When in the CHOP mode, the channel signals are chopped in sequence at a rate of about 1 μ sec (1 MHz). Multichannel traces are simultaneously displayed in a time-slicing method. When signal frequencies are high, the waveforms may be displayed with dotted lines. In such cases the ALT mode should be used.

When in the ALT mode, one channel is displayed for an entire sweep, then the next channel is displayed for an entire sweep. This mode is used primarily for display of high frequency signals at fast sweep speeds. At very low sweep speeds, signals are displayed alternately. In such cases the CHOP mode should be used.

Note: The multichannel operation can be done with any combinations of CH1, ADD (CH1 + CH2), CH2, CH3 (TRIG VIEW).

(3) ADD operation

An algebraic sum of CH1 and CH2 signals can be displayed on the screen by depressing the ADD switch. The displayed

signal is the difference between CH1 and CH2 signals if the CH2 POLARITY switch is set in the INV (pulled out CH2 position knob) state.

For accurate addition or subtraction, it is a prerequisite that the sensitivities of the two channels are adjusted accurately to the same value. Vertical positioning can be done with the POSITION knob of either channel. In view of the linearities of the vertical amplifiers, it is most advantageous to set them in their mid-position.

4.5 CH3 HOR Operation

When the A TIME/DIV switch (31) is set in the

X-Y	CH3 HOR
-----	---------

 position, the oscilloscope operates as a multichannel X-Y scope with the channels (except CH3) selected by the vertical mode switches as the Y axis and CH3 as the X axis. The bandwidth of the X axis becomes DC - 2 MHz (-3 dB). Other electrical performances are the same as CH3. Regarding the Y axis, the channels selected by the vertical mode switches are displayed in the CHOP mode, with the electrical performances and the operation method remaining the same.

X-Y operation

Simply by depressing the CH2 (X-Y) (19) button, A, B TIME/DIV (31) switches to the

X-Y	CH3 HOR
-----	---------

 position, also INT TRIG (18) switches to the X-Y and SOURCE (23) switches to the X-Y as the result the oscilloscope operates as an X-Y scope. The X-Y operation is with CH1 as X axis and CH2 as Y axis. The bandwidth of the X axis is DC to 2 MHz (-3 dB). Other electrical performances remain the same as when the circuit is used as the CH1 vertical channel. The Y axis operates with the same electrical performances as when the circuit is used as the CH2 vertical channel, and its operation method remains the same.

When the calibration voltage signal is applied to the input terminals of both X and Y axis with the P060-S 10:1 Probes (supplied) and the corresponding VOLTS/DIV switches are properly adjusted, a Lissajous figure as shown in Figure 4-3 will be displayed.

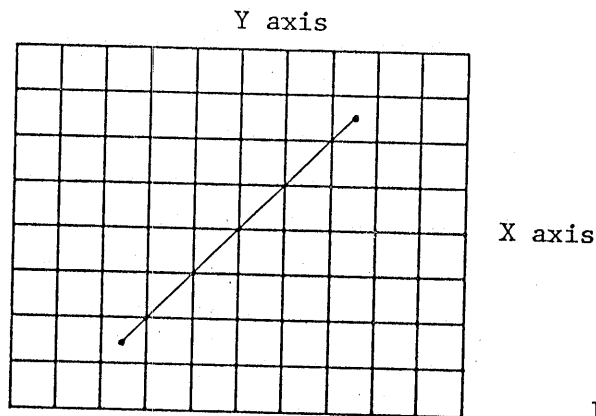

Figure 4-5

Note: When high frequency signals are displayed in the X-Y operation, pay attention to the frequency bandwidths of and phase difference between X and Y axes.

4.6 Triggering

Proper triggering is essential for efficient operation of an oscilloscope. The user of the oscilloscope must make himself thoroughly familiar with the triggering functions and procedures.

(1) Functions of INT TRIG (internal trigger) switch:

The signals applied to the input terminals of CH1, CH2 are picked off from respective preamplifiers in order to be used as internal trigger signals. The INT TRIG switch selects these signals. The selected signals are sent to the A trigger circuit through the SOURCE switch. The relationships of these circuits are shown in the block diagram of Figure 4-6.

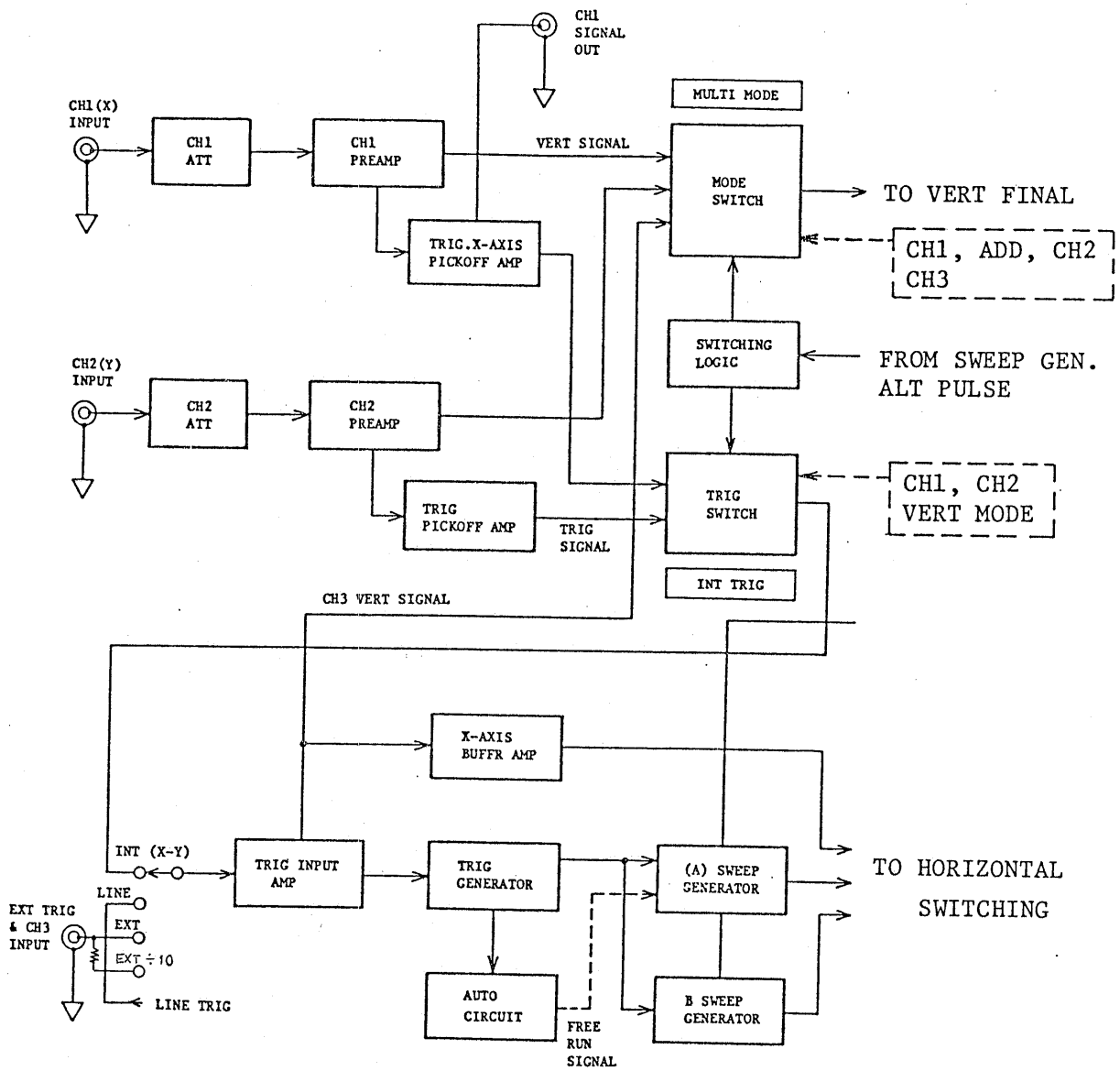

Figure 4-6

With the INT TRIG switch the internal trigger signal can be selected as follows.

- CH1: Input signal of CH1
- CH2: Input signal of CH2
- VERT MODE: All signals being displayed on screen

As can be seen in the block diagram, the triggering circuits are designed with certain relationships to the vertical mode selector switches. These relationships are shown in the following table.

INT TRIG \ MODE	CH1	ADD	CH2	TRIG VIEW
	CH3			
CH1	Trig by CH1			
CH2	Trig by CH2			
VERT MODE	Trig by CH1	Trig by CH1	Trig by CH2	Trig by CH1

- Notes:
1. When in the VERT mode trigger function, signals of CH1, CH2 use the same trigger circuit alternately. Therefore, these signals must cross the same trigger level. Pay attention to the DC components of these signals. It is necessary to use TRIG LEVEL knob (21) and DC trig coupling for best triggering.
 2. Note that jitter may be produced when the sweep speed is slow if the SOURCE switch is set for AC coupling.
 3. The VERT MODE trigger function for vertical modes is effective only when in the single-channel operation and when in the ALT-mode multichannel operation. It is not effective when in the CHOP mode.
 4. 3 cycles or more on the CRT must be displayed to obtain complete triggering signal observation.

(2) Function of SOURCE Switch:

To display a stationary pattern on the CRT screen, the displayed signal itself or a trigger signal which has a time relationship with the displayed signal is required to be applied to the trigger circuit. The SOURCE switch selects such a trigger source.

INT: This internal trigger method is used most commonly. The signal applied to the vertical input terminal (the measured signal) is branched off from a point in the amplifier circuit and is fed to the trigger circuit through the INT TRIG switch. Since the trigger signal is the measured signal itself, a very stable waveform can be readily displayed on the CRT screen.

LINE: The AC power line frequency signal is used as the trigger signal. This method is effective when the measured signal has a relationship with the AC line frequency, especially for measurements of low level AC noise of audio circuits, thyristor circuits, etc.

EXT: The sweep is triggered with an external signal applied (CH3) to the external trigger input terminal. An external signal which has a periodic relationship with respect to the measured signal is used. Since the measured signal (vertical input signal) is not used as the trigger signal, the waveform display can be done independent of the measured signal.

EXT ÷ 10: The external trigger signal applied to the external trigger input terminal is attenuated into 1/10 before being applied to the trigger circuit. Operation is the same with those of the EXT trigger mode. This mode is used when the external trigger signal level is too high.

(3) Functions of the COUPLING switch:

This switch is used to select the coupling of the trigger signal to the trigger circuit in accordance with the characteristics of the measured signal.

AC: This coupling is for AC triggering which is used most commonly. As the trigger signal is applied to the trigger circuit through an AC coupling circuit, stable triggering can be attained without being affected by the DC component of the input signal. The low-range cut off frequency is an approx. 10 Hz (-3 dB).

When the VERT MODE trigger function is used and the sweep speed is slow, jitter may be produced. In such a case, use the DC mode.

HF REJ: The trigger signal is fed to the trigger circuit through an AC coupling circuit and a low pass filter (approximately 50 kHz, -3 dB). The higher frequency components of the trigger signal are rejected. Only the lower frequency components of the trigger signal are applied to the trigger circuit.

TV: This coupling is triggering of TV video signals. The trigger signal is AC-coupled and fed via the trigger circuit (level circuit) to the TV sync separator circuit. The separator circuit picks off the sync signal, which is used to trigger the sweep. Thus, the video signal can be displayed very stably.

Being linked to the TIME/DIV switch, the sweep speed is switched for TV.V and TV.H as follows:

TV.V: 0.5 sec - 0.1 msec

TV.H: 50 μ sec - 50 nsec

The SLOPE switch should be set in conformity with the video signal as shown in Figure 4-7.

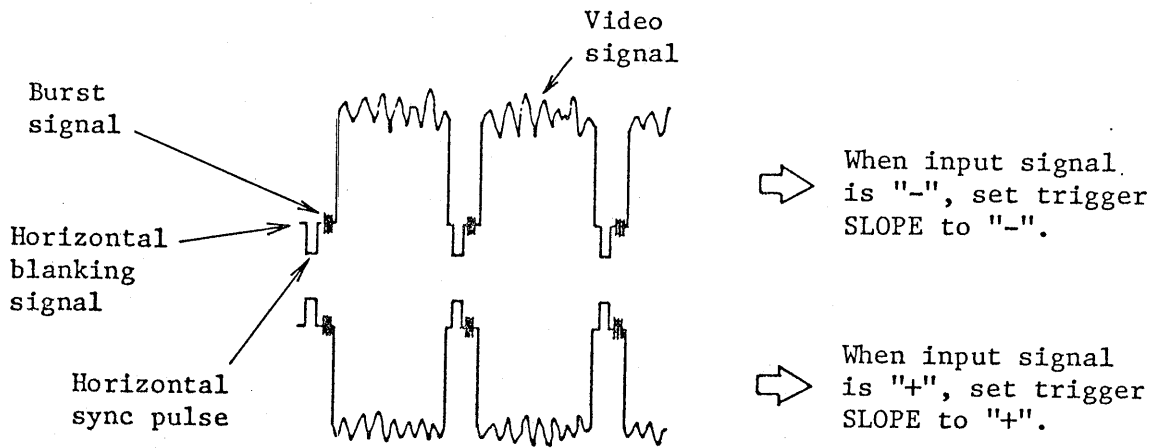

Horizontal field video signal

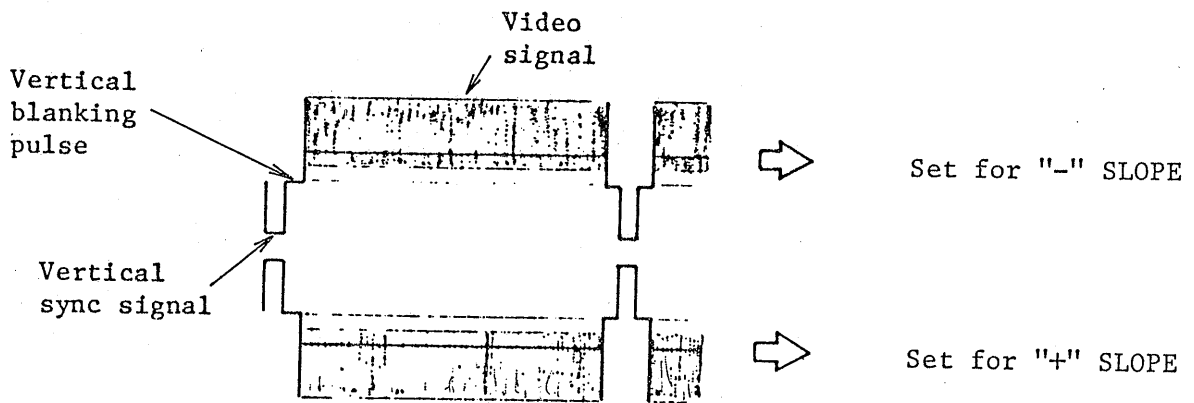

Vertical field video signal

Figure 4-7

DC: The trigger signal is DC-coupled to the trigger circuit. This mode is used when triggering on a DC component of a signal or when triggering on very low frequency signals.

(4) Functions of the SLOPE switch:

This switch selects the slope (polarity) of the trigger signal.

"+": When set in the "+" state, triggering occurs as the trigger signal crosses the trigger level in the positive-going direction.

"-": When set in the "-" state, triggering occurs as the trigger signal crosses the trigger level in the negative-going direction.

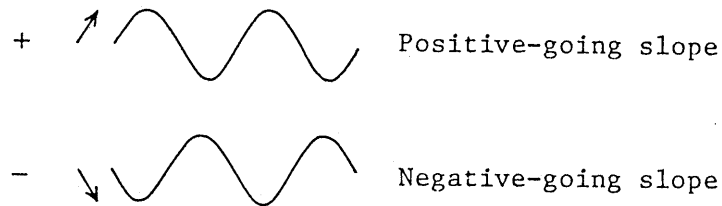

Figure 4-8

(5) Functions of LEVEL (LOCK) control:

The function of this control is to adjust the trigger level and display a stationary image. At the instant the trigger signal has crossed the trigger level set by this control, the sweep is triggered and a waveform is displayed on the screen.

The trigger level changes in the positive direction (upward) as this control knob is turned clockwise, and it changes in the negative direction (downward) as the knob is turned counterclockwise. The rate of change is set as shown in Figure 4-9.

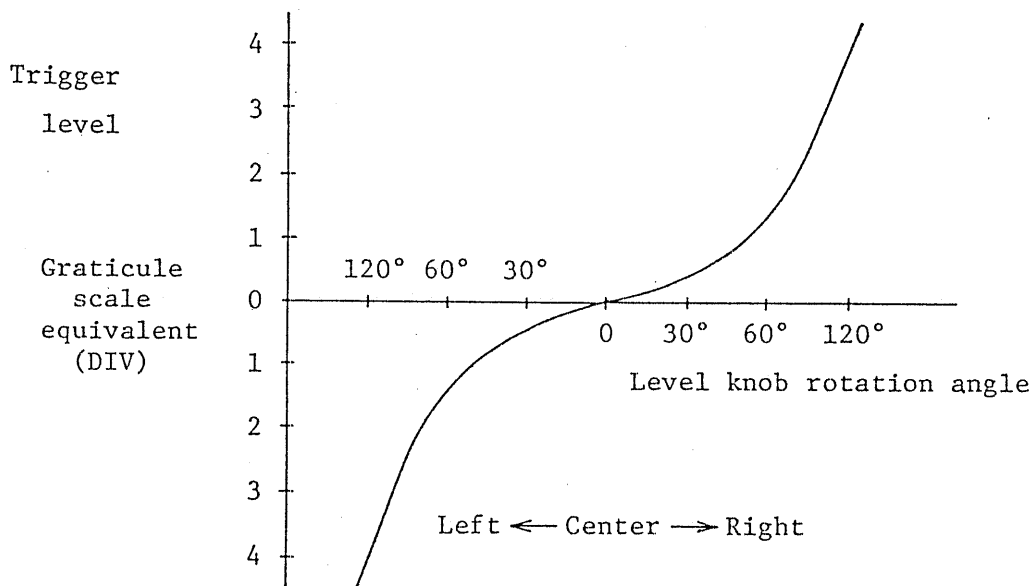

Figure 4-9

o LEVEL LOCK

When the LEVEL knob is set in the LEVEL LOCK position, the trigger level is automatically maintained within the amplitude of the trigger signal and stable triggering can be done without requiring level adjustment (although jitter may not be suppressed when in the VERT MODE trigger function). This automatic level lock function is effective when the signal amplitude on the screen or the external trigger input voltage is within the following range:

50 Hz - 10 MHz: 0.9 DIV (0.09 V) or less

50 Hz - 50 MHz: 2.0 DIV (0.2 V) or less

(6) Functions of A HOLD OFF control:

When the measured signal is a complex waveform with two or more repetition frequencies (periods), triggering with the above-mentioned LEVEL control alone may not be sufficient for attaining a stable waveform display. In such a case, the sweep can be stably synchronized to the measured signal

waveform by adjusting the HOLD OFF time (sweep pause time) of the sweep waveform. The control covers 2 times or over of sweep length (time) at 0.05 μ sec/DIV - 10 msec/DIV ranges.

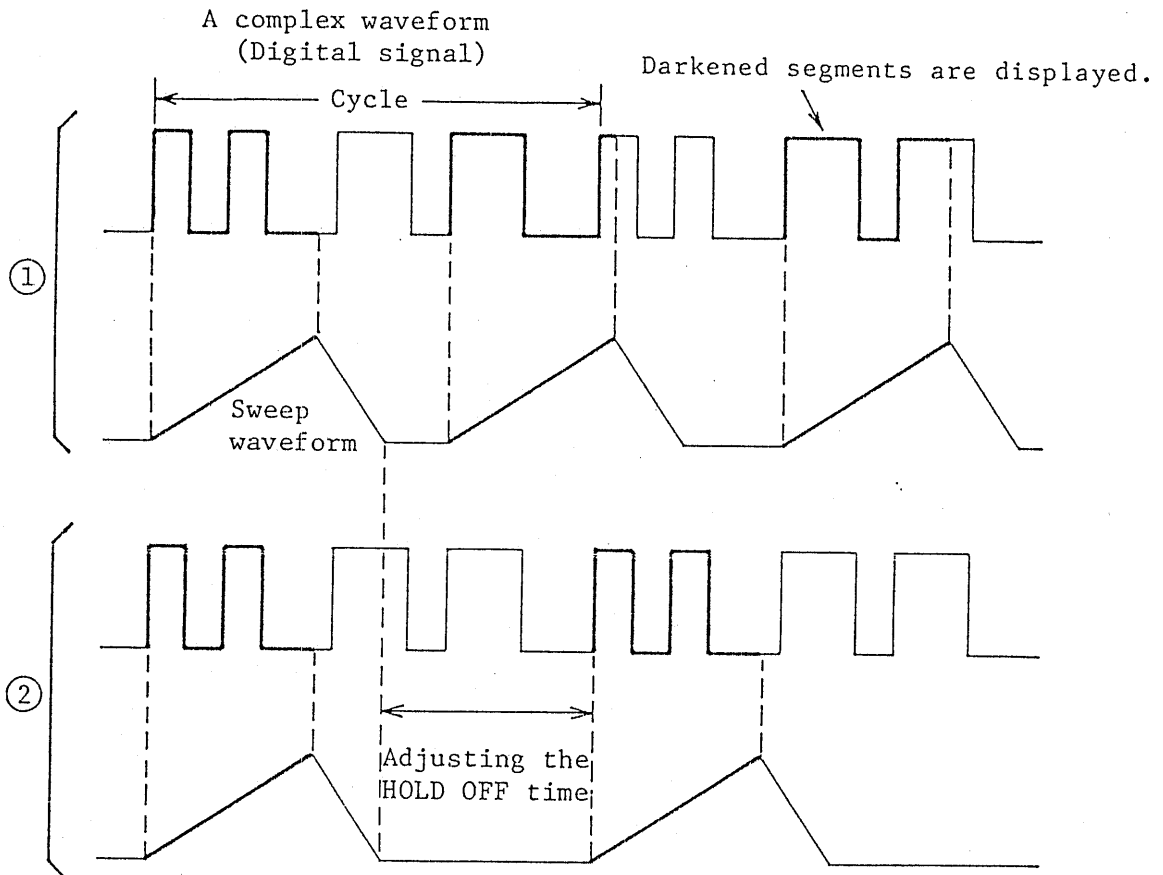

Figure 4-10

Figure 4-10 ① shows a case where the HOLD OFF knob is in the NORM state and various different waveforms are overlapped on the screen, making the signal observation unsuccessful.

Figure 4-10 ② shows a case where the undesirable portion of the signal is with held and the same waveforms are displayed on the screen.

4.7 Single-sweep Operation

Non-repetitive signals and one-shot transient signals can hardly be observed on the screen. Such signals can be measured by displaying them in the single-sweep mode on the screen and photographing them.

o Measurement of non-repetitive signal:

- (1) Set the HORIZONTAL DISPLAY in the "A" state and the SWEEP MODE in the NORM state.
- (2) Apply the measured signal to the vertical input terminal and adjust the trigger level.
- (3) Set the SWEEP MODE in the SINGLE state (the three push-button switches are up).
- (4) Press the RESET button. The sweep will run only for one cycle and the measured signal will be displayed only once on the screen.

o Measurement of one-shot signal:

- (1) Set the HORIZONTAL DISPLAY in the "A" state and the SWEEP MODE in the NORM state.
- (2) Apply the calibration output signal to the vertical input terminal, and adjust the trigger level to a value corresponding to the predicted amplitude of the measured signal.
- (3) Set the SWEEP MODE in the SINGLE state. Apply the measured signal instead of the calibration signal to the vertical input terminal.
- (4) Depress the RESET button. The sweep circuit will become the ready state and the READY lamp will turn on.
- (5) As the one-shot signal occurs in the input circuit, the sweep runs only for one cycle and the one-shot signal is displayed on the CRT screen.

The single-sweep operation can be done also with ALT and B sweep of the delayed sweep. However, it cannot be done in the multi-channel ALT mode operation. For multichannel one-sweep operation, use the CHOP mode.

4.8 Sweep Magnification

When a certain part of the displayed waveform needs to be magnified, a faster sweep speed (MAG) may be used. In such a case, pull out the sweep VARIABLE knob (33) (set in the $\times 10$ MAG state). When this is done, the displayed waveform is expanded by 10 times. The center of the waveform will be displayed. Any part can be covered by means of POSITION control.

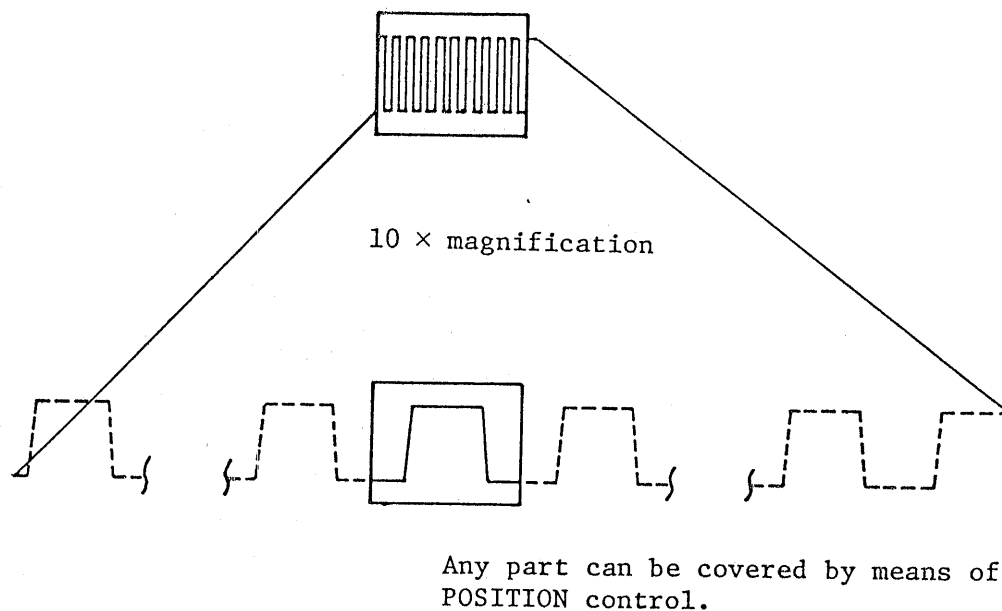

Figure 4-11

The sweep time when in the magnification operation is as follows:

$$(\text{Value indicated by TIME/DIV switch}) \times 1/10$$

Thus, the maximum sweep speed 50 nsec/DIV can be made faster with magnification as follows:

$$50 \text{ nsec/DIV} \times 1/10 = 5 \text{ nsec/DIV}$$

When the sweep is magnified and the sweep speed has become faster than 50 nsec/DIV, the trace intensity may be reduced. In such a case, the displayed waveform should be expanded in the B sweep mode explained in the subsequent paragraphs.

4.9 Waveform Magnification with Delayed Sweep

With sweep magnification (described above), the magnification ratio is limited to $\times 10$. With the delayed sweep method, the sweep can be expanded for a wide range from several times to several thousand times depending on the ratio between A sweep time and B sweep time.

As the measured signal frequency becomes high and the A sweep range for the non-expanded signal increases, the available expansion ratio becomes smaller. Furthermore, as the magnification ratio becomes larger, the trace intensity becomes lower and the delay jitter increases. To cope with this situation, a triggered delay circuit.

4.10 Delayed ALT Sweep

When in the Delayed ALT sweep mode, the A sweep and B sweep (delayed sweep) are displayed alternately on the screen, enabling you to observe at the same time the unmagnified waveform and magnified section.

To prevent the two waveforms from overlapping and to display them separately, adjusted the TRACE SEP control (35).

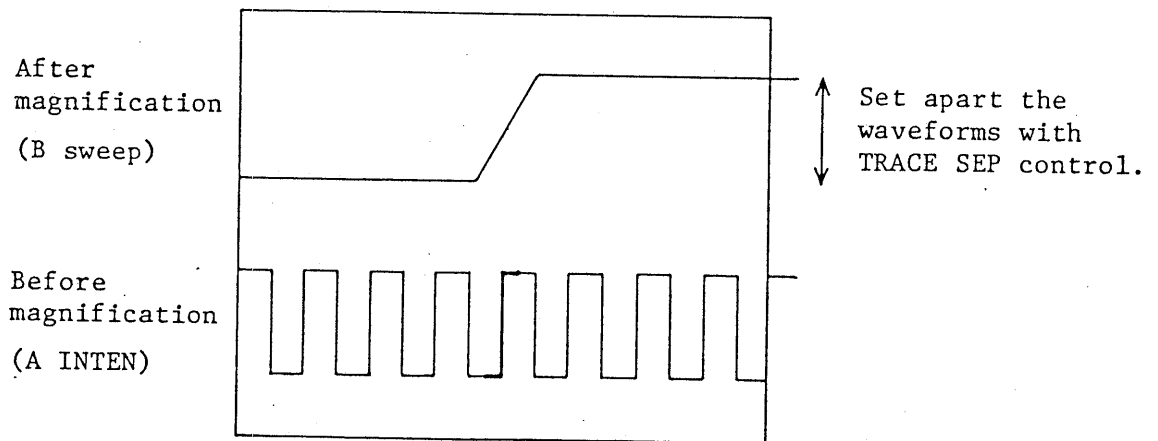

Figure 4-12

Note: The delayed ALT sweep mode can be used in combination with the MULTI MODE (CHOP or ALT) of the vertical axis.

(1) Continuous delay:

Set the DISPLAY switch to A and display the signal waveform with the A sweep in the regular operation method.

Next, set the B TIME/DIV switch to a position faster than that of the A TIME/DIV switch.

Turn the HOR DISPLAY switch to the ALT position. A part of the displayed waveform will be accentuated as shown in Figure 4-12, indicating the state ready for delayed sweep. The intensified portion denotes the section corresponding to the B sweep time (DELAYED SWEEP) (32).

The period from the start of the A sweep to the beginning of B sweep (the accentuated portion of the trace) is called "SWEEP DELAY TIME." This period is continuously variable by means of the DELAY TIME MULTI dial (34).

Next, change the DISPLAY switch to the B position. The B sweep time will be expanded to a full sweep (10 cm) as shown Figure 4-14.

The B sweep time is set by the B TIME/DIV switch and the magnification ratio becomes as follows:

$$\text{Magnification ratio} = \frac{\text{A TIME/DIV indication}}{\text{B TIME/DIV indication}}$$

The sweep delay time can be read on the CRT screen. For more accurate determination, the DELAY TIME MULTI dial should be used.

$$\text{Sweep delay time} = \left(\text{A TIME/DIV indication} \right) \times \left(\text{DELAY TIME MULTI dial setting} \right)$$

HORIZ DISPLAY
ALT

Figure 4-13

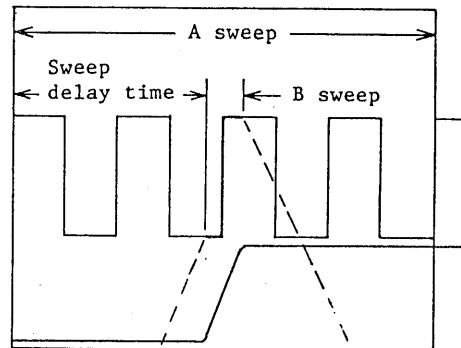

HORIZ DISPLAY
B

Figure 4-14

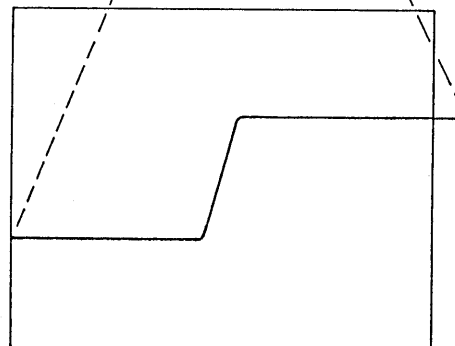

(2) Triggered delay:

When the displayed waveform is magnified by 100 times or more by the continuous delay method, delay jitter is produced. To suppress the jitter, a triggered delay method may be used. The

function operates by depressing the B TRIG'D button.
B trigger signal is used commonly A trigger signal.

Therefore, even when the delay time is continuously varied by rotating the DELAY TIME MULTI dial, the starting point does not vary continuously but varies intermittently. This operation when in the ALT mode can be observed as the intensified section jumps from trigger point to trigger point on the A sweep waveform.

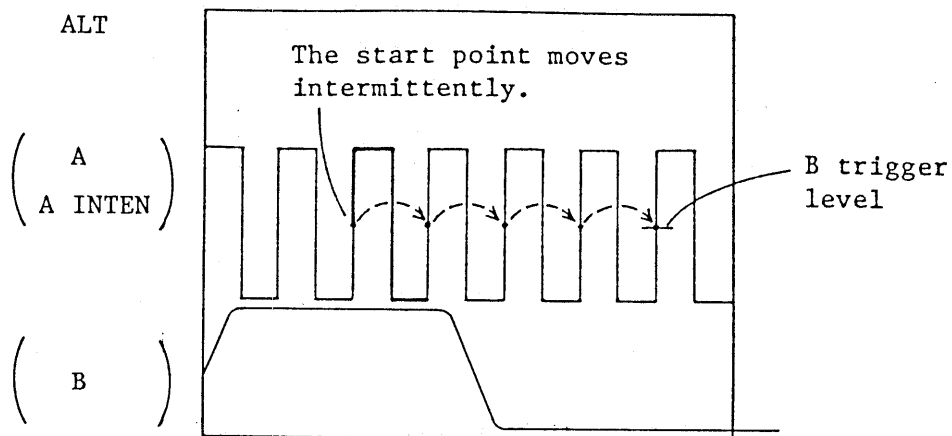

Figure 4-15

5. MEASURING

5.1 Connection Method of Input Signal

The input impedance of the oscilloscope as viewed from the vertical input terminal is $1\text{ M}\Omega$ with capacitance approximately 25 pF in parallel. When a 10:1 probe is used, the impedance increases to a resistance of $10\text{ M}\Omega$ with a capacitance of approximately 23 pF in parallel.

There are various methods of connecting the signal sources to the oscilloscope. The most popular methods are with regular covered wires, with shielded wires, with a probe, or with a coaxial cable. The following factors should be considered.

Output impedance of input signal source

Level and frequency of input signal

External induction

Distance between the input signal source and the oscilloscope

Types of input signals and connection methods are tabulated in the following:

Type of input signal		Connection method		Probe	Coaxial cable
		Near	Far		
Low frequency	Low impedance	Near		○	○
		Far			○
	High impedance	Near		○	⊗
		Far			⊗
High frequency	Low impedance	Near		○	○
		Far			○
	High impedance	Near		○	⊗
		Far			

(○: Good, ⊗: Fair)

o Connection with coaxial cable:

When the output impedance of the signal source is 50Ω or 75Ω , the input signal can be fed without attenuation by using a coaxial cable which enables impedance matching. For impedance matching, terminate the coaxial cable with a 50Ω or 75Ω pure-resistive resistor corresponding to the characteristic impedance of the coaxial cable, as shown in Figure 5-1.

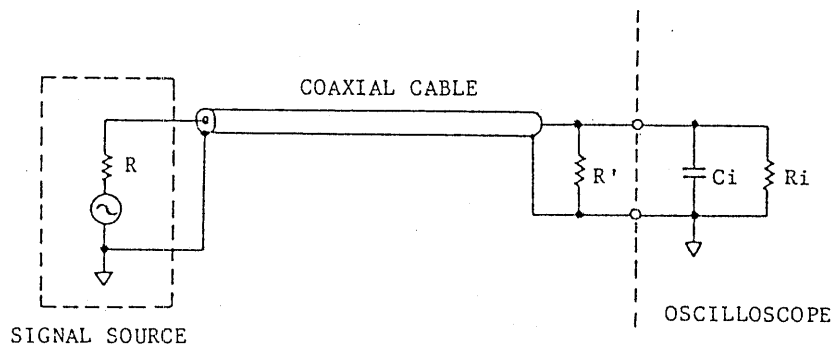

$$R = R'$$

When $R = 50\Omega$, use a 50Ω coaxial cable.

When $R = 75\Omega$, use a 75Ω coaxial cable.

Figure 5-1

o Connection with probe;

Two probes with an attenuation ratio of 10:1 are supplied. The probe circuit and probe cable are shielded to prevent induction noise. The probe circuit makes up a wide-range attenuator in conjunction with the input circuit of the oscilloscope, thereby enabling a distortionless connection from DC to high frequencies. When the probe is used, although the signal level is attenuated to 1/10, the input impedance becomes very high (resistance $10\text{ M}\Omega$, capacitance approx. 23 pF) and the loading effect on the measured signal source is greatly reduced as explained in the following.

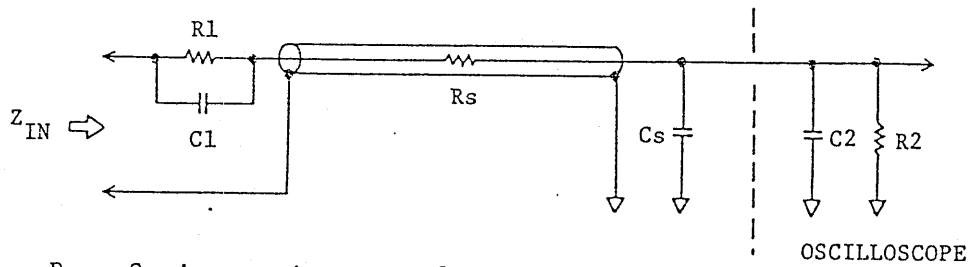

R_s = Series resistance of cable

C_s = Stray capacitance plus cable capacitance

Figure 5-2

The probe makes up an attenuator with resistor R_1 , in the probe, and the input resistor R_2 , in the oscilloscope. Capacitor C_1 compensates for input capacitor C_2 in the oscilloscope and stray capacitance (C_s) in the cable. The input impedance Z_{IN} is expressed as follows:

$$Z_{IN} = \frac{R_1 + R_2}{\omega C (R_1 + R_2) + 1}$$

$$C = \frac{C_1 \times (C_2 + C_s)}{C_1 + C_2 + C_s}$$

Attenuation ratio A is expressed as follows:

$$A = \frac{R_2}{R_1 + R_2} \quad \left(= \frac{1 \text{ M}\Omega}{9 \text{ M}\Omega + 1 \text{ M}\Omega} = \frac{1}{10} \right)$$

The terms enclosed in the parentheses are for the factor when the probe is used:

Precautions:

- o Observe the maximum allowable input voltages mentioned in Section 3.5.
- o Do not fail to use the ground lead supplied.
- o Before taking a measurement, accurately adjust the frequency compensation of the probe.
- o Do not apply large mechanical shocks or vibration to the probe. Do not sharply bend or strongly pull the probe cable.

- o The probe unit and tip are not highly heat resistant. Do not apply a soldering iron to a circuit close to the point where the probe is attached.

Characteristics of the 1:1 probe are the same as coaxial cable.

5.2 Voltage Measurement

To measure the AC portion of a signal which has DC superimposed on the AC component, set the vertical input AC/DC selector switches (7) and (16) in the AC position. To measure the DC component of a signal, set the switch in the DC position.

Before making a voltage measurement, set the VARIABLE attenuator knobs (11) and (14) at the CAL'D position and calibrate the sensitivity to the value indicated by the VOLTS/DIV selector switches (10) and (13).

Apply the signal to be measured, display the signal with an appropriate amplitude on the screen, and determine the amplitude on the graticule. For a DC voltage measurement, determine the shifted distance of the trace. The voltage can be determined as follows:

- (1) When a measured signal is directly applied to an input terminal:

$$\text{Voltage (V)} = \text{Deflection amplitude (DIV)} \times \text{VOLTS/DIV}$$

- (2) When the 10:1 probe is used:

$$\text{Voltage (V)} = \text{Deflection amplitude (DIV)} \times \text{VOLTS/DIV} \times 10$$

- (3) $\times 5$ MAG when (11), (14) VARIABLE knobs are pulled out.

$$\text{Voltage (V)} = \text{Deflection amplitude (DIV)} \times \text{VOLTS/DIV} \div 5$$

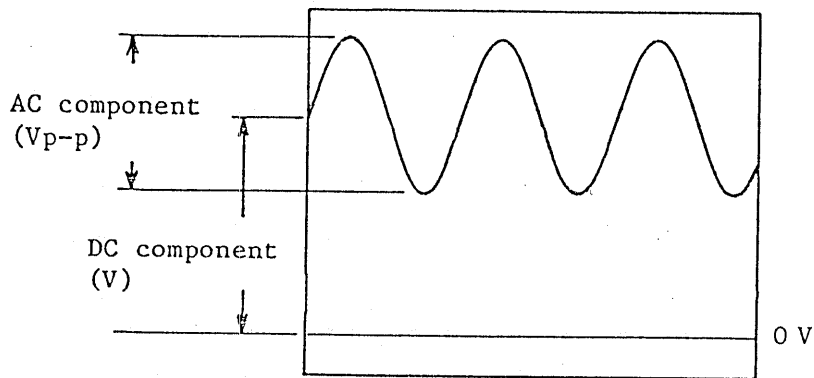

AC-GND-DC Switch: DC

Figure 5-3

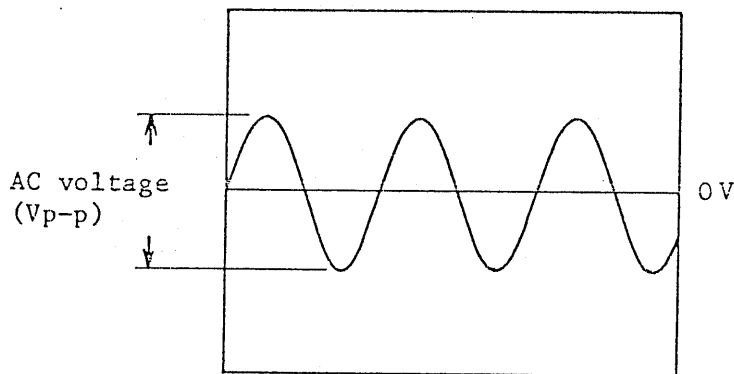

AC-GND-DC Switch: AC

5.3 Current Measurement

Connect a small resistor (R) in series in the circuit in which the current (I) to be measured flows and measure the voltage drop across the resistor with the oscilloscope. The current is known from Ohm's law as follows:

$$I = \frac{E}{R} \quad (A)$$

The resistance should be as small as possible so it does not cause a change in the measured signal source.

In the above method, currents from DC to high frequencies can be measured quite accurately. Note that the accuracy of the resistor reflects upon the measuring accuracy.

5.4 Time Measurement

The time interval between any two points on the displayed waveform can be measured by setting the TIME/DIV VARIABLE knob (33) in the CAL'D position and referring to the indication of the TIME/DIV switch (31).

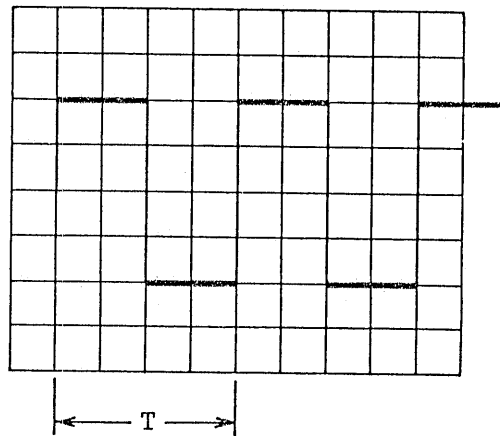

Figure 5-4

$$\text{Time T (sec)} = \text{Indication of TIME DIV} \times \text{Horizontal span (DIV)}$$

When the sweep is magnified ($\times 10$ MAG (33) pulled), the time is 1/10 of the value determined as above.

5.5 Frequency Measurement

- o Frequency measurement by determining time (T) per one cycle of the displayed waveform:

Time T (period) is measured as explained in section 5.4 and the frequency is known by using the following formula.

$$\text{Frequency } f \text{ (Hz)} = \frac{1}{\text{Period T (sec)}}$$

- o Frequency measurement with Lissajous figure (See Figure 5-5 and 5-6):

Refer page 30 . How to set the X-Y operation.

Apply to the X-axis a known frequency from a signal generator (SG) and to the Y-axis the frequency to be measured. Adjust the required controls so that a pattern is displayed on the full surface of the CRT screen. Then adjust the frequency of the signal generator so that the displayed pattern becomes stationary as shown in Figure 5-4. From the displayed waveform, the unknown frequency can be calculated as follows:

$$\text{Unknown Frequency (Hz)} = \frac{\text{The number of crossing points over horizontal scale line}}{\text{The number of crossing points over vertical scale line}} \times \text{Frequency of signal generator (Hz)}$$

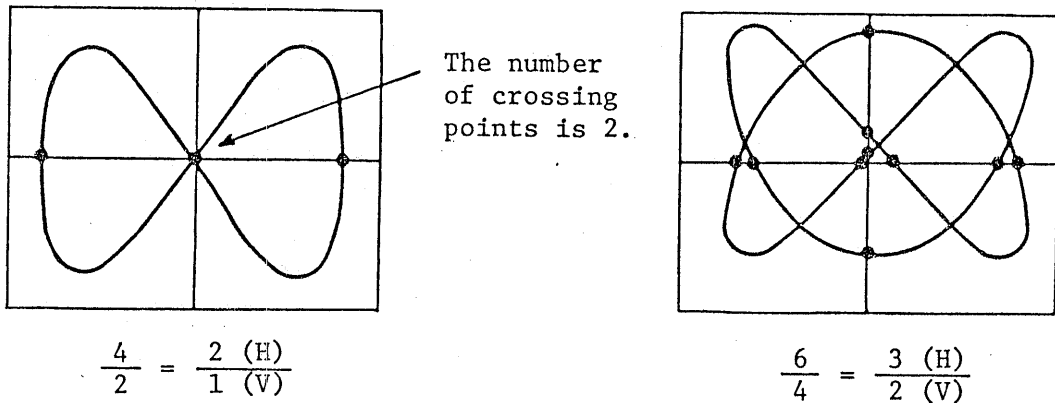

Figure 5-5

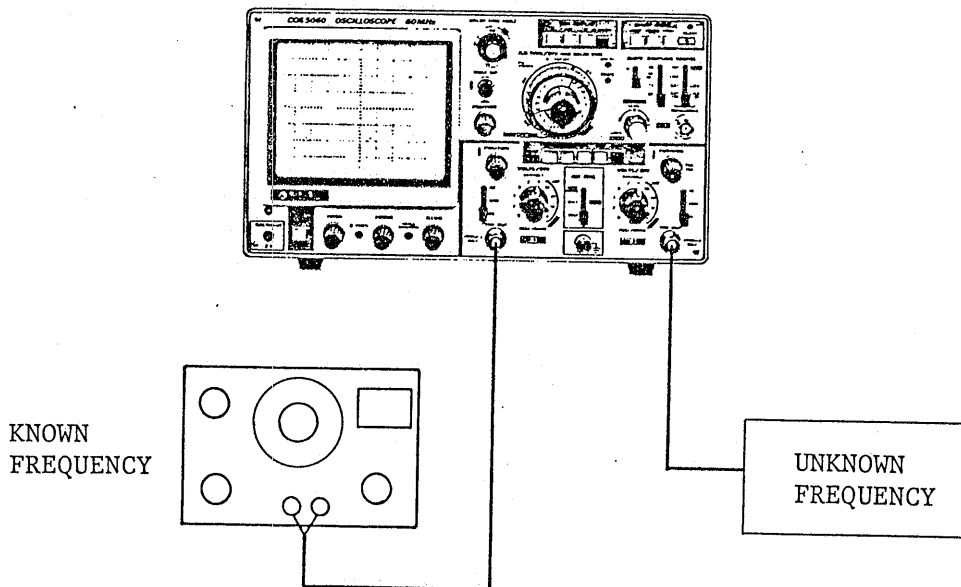

Figure 5-6

5.6 Measurement of Phase Difference

- o Measurement of phase difference with Lissajous figure
(See Figures 5-6, 5-7 and 5-8):

Operate the oscilloscope in the X-Y mode as explained in the paragraph for frequency measurement, and apply two signals of the same frequency (such as stereophonic signals) to the X and Y axes so that a Lissajous figure is displayed on the CRT screen. The phase difference between the two signals can be calculated by measuring the displayed waveform and employing the following equation:

$$\text{Phase difference } \theta = \sin^{-1} \frac{B}{A}$$

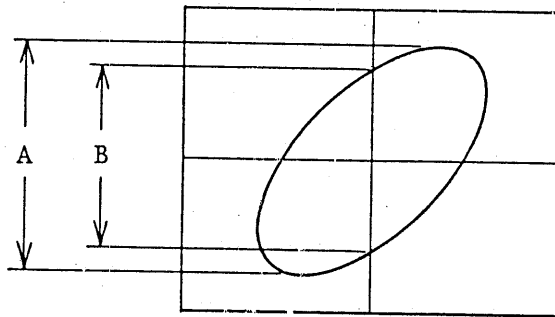

Figure 5-7

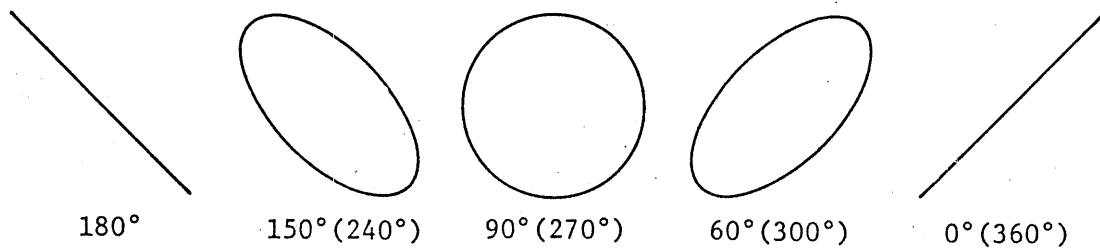

Figure 5-8

5.7 Characteristics of Pulse Waveform

A theoretically ideal pulse waveform is such that the signal changes instantaneously from one level to another, held in this level for a period of time and returns instantaneously to the original level. However, actual pulse waves are distorted. Nomenclature of distortions is given in Figure 5-9.

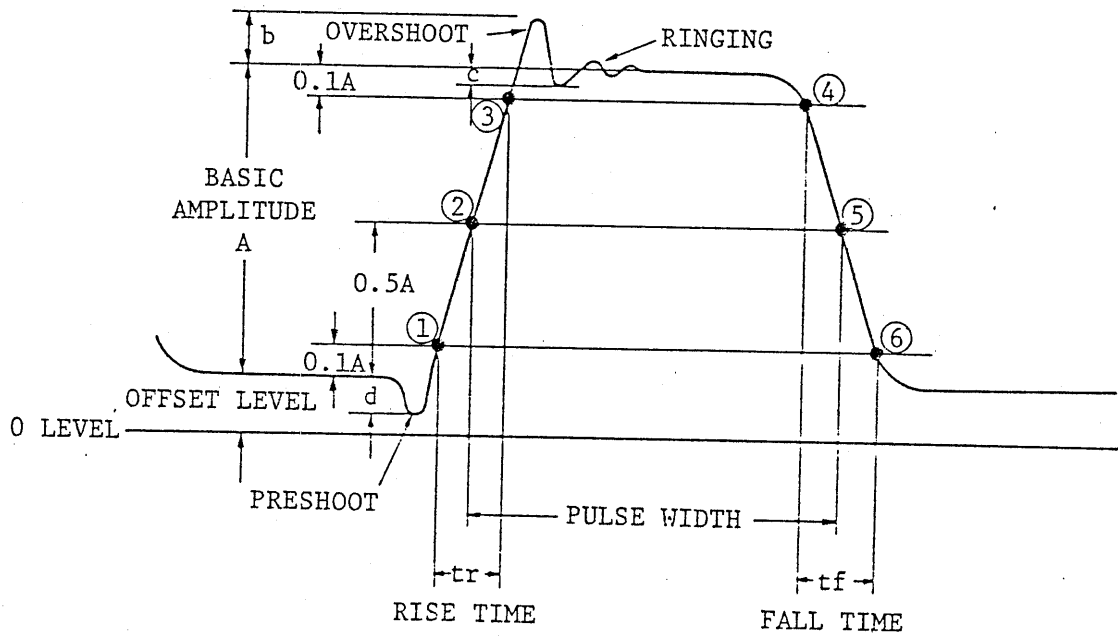

Figure 5-9

Pulse amplitude: Basic amplitude (A) of pulse

Pulse width: Time between points ② and ⑤ where signal amplitude is 50% of basic amplitude

Rise time: Time between 10% basic amplitude point ① and 90% basic amplitude point ③

Fall time: Time between 90% basic amplitude point ④ and 10% basic amplitude point ⑥

Overshoot: Amplitude of the first maximum excursion beyond basic amplitude. Expressed in terms of $b/A \times 100$ (%)

Ringling: Oscillation which follows the first maximum excursion. Expressed in terms of $c/A \times 100$ (%)

Preshoot: Amplitude change (rise or fall) which precedes rise up of main pulse. Expressed in terms of $d/A \times 10$ (%)

Hole: Amplitude fall that occurs after rise up of main pulse. Expressed in terms of $e/A \times 100$ (%)

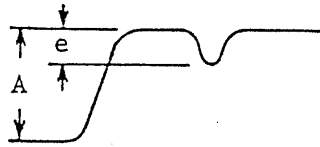

Bump: Amplitude rise that occurs after rise up of main pulse. Expressed in terms of $f/A \times 100$ (%)

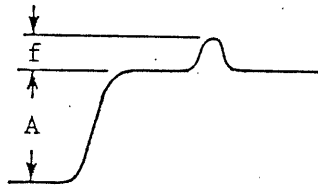

(Refer to EIAJ MEA-27A or IEC PUB. 351-1.)

o Measurement of rise time:

The rise time of a pulse can be calculated by determining the value of t_r on the CRT screen in the method of "Time Measurement." It must be noted that t_r determined on the CRT screen includes the rise time of the oscilloscope itself. The closer the rise time of the oscilloscope (t_o) to the rise time of the measured pulse (t_n), the larger is the error introduced. To eliminate this error, calculation should be done as follows:

$$\text{True rise time } t_n = \sqrt{(t_r)^2 - (t_o)^2}$$

where, t_r : Rise time measured on CRT screen

t_o : Rise time of oscilloscope itself

(approx. 6.0 nsec)

For example, when a pulse wave with a rise time of 20 nsec (approx. 3 times that of the oscilloscope) is measured on the CRT screen, the error is approximately 6%.

o Measurement of Sag

Pulse waveforms may have slanted sections as shown in Figure 5-10, in addition to those distortions mentioned in Figure 5-9. Slants are caused when the signal is amplified with an amplifier which has poor low-frequency characteristics, resulting from attenuation of low frequency components. The slanted section (d or d') is called "sag" and is calculated as follows:

$$\text{Sag} = \frac{d}{A} \quad (\text{or } \frac{d'}{A'}) \times 100 (\%)$$

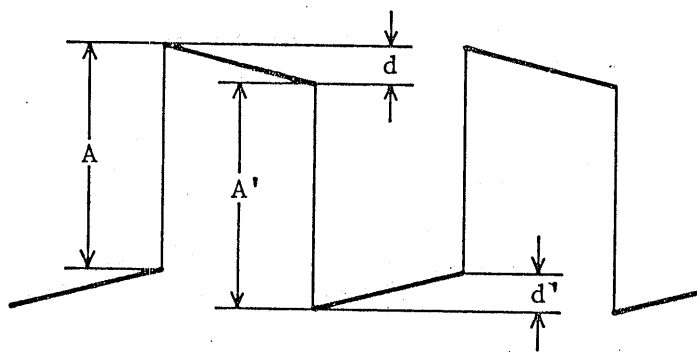

Figure 5-10

Note: If the AC-coupling mode is used for measurement of a low frequency pulse, sag is caused. For measurement of low frequency pulses, use always the DC-coupling mode.

5.8 Calibration of Probe

As explained previously, the probe makes up a kind of wide-range attenuator. Unless phase compensation is properly done, the displayed waveform is distorted causing measurement errors. Therefore, the probe must be properly calibrated before use. For probe calibration, use the signal of the calibration voltage output terminal (40) of the front panel.

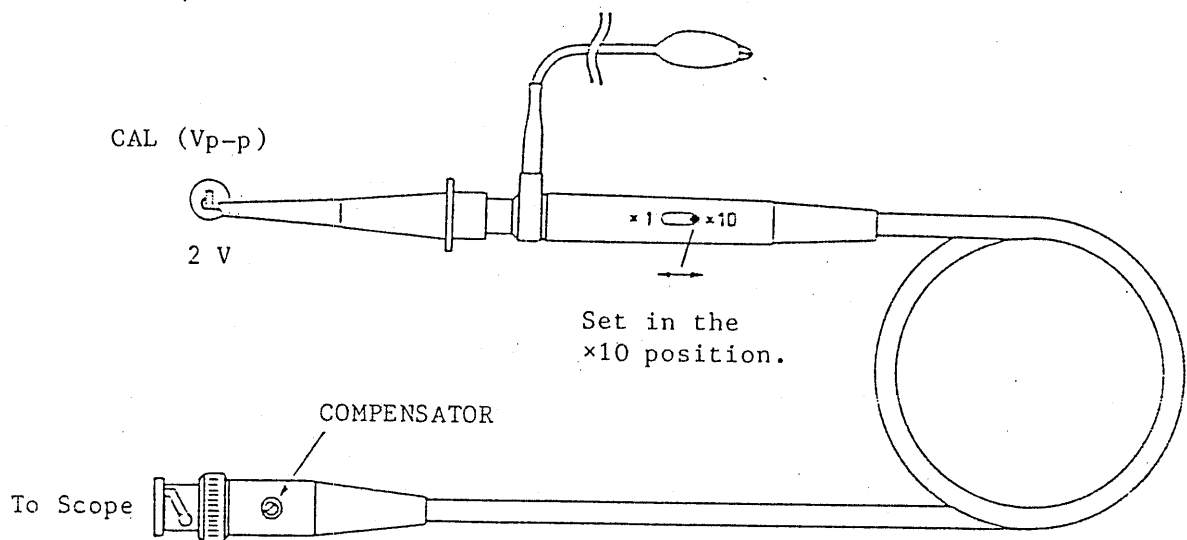

Figure 5-11

Connect the probe BNC to the INPUT terminal of CH1 or CH2 and set VOLTS/DIV switch at 50mV. Connect the probe tip to the calibration voltage output terminal and adjust the COMPENSATOR control with an insulated screwdriver so that an ideal waveform as illustrated below is obtained.

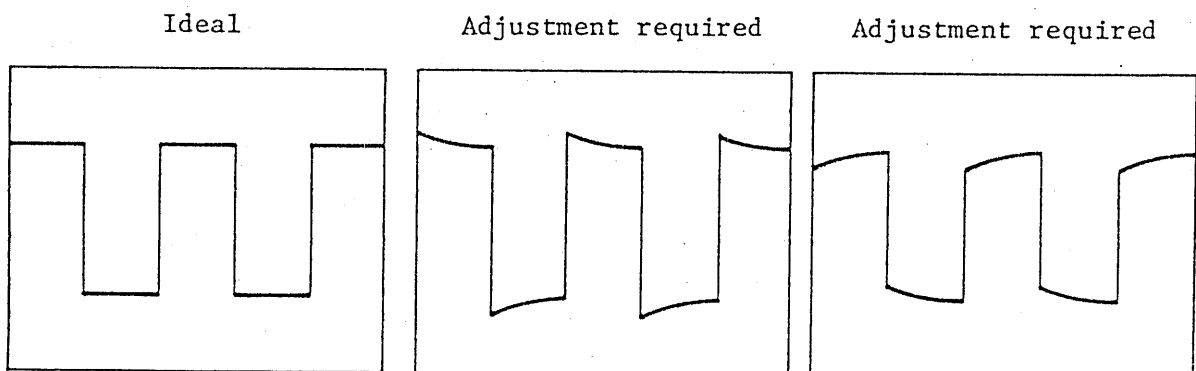
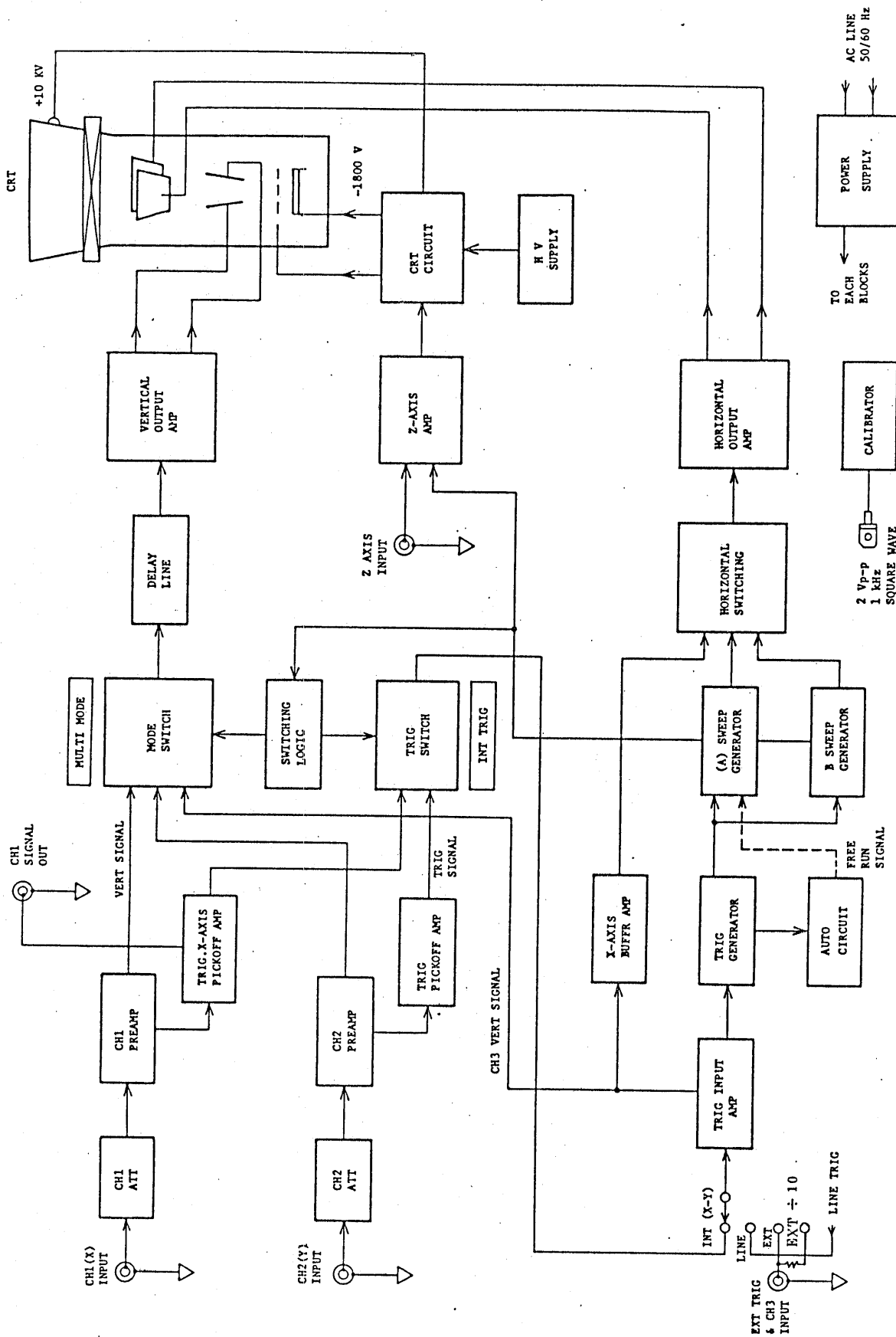

Figure 5-12



BLOCK DIAGRAM